

# TCL • Roku TV

---

## User Guide

Version 12.0

*For United States*

English

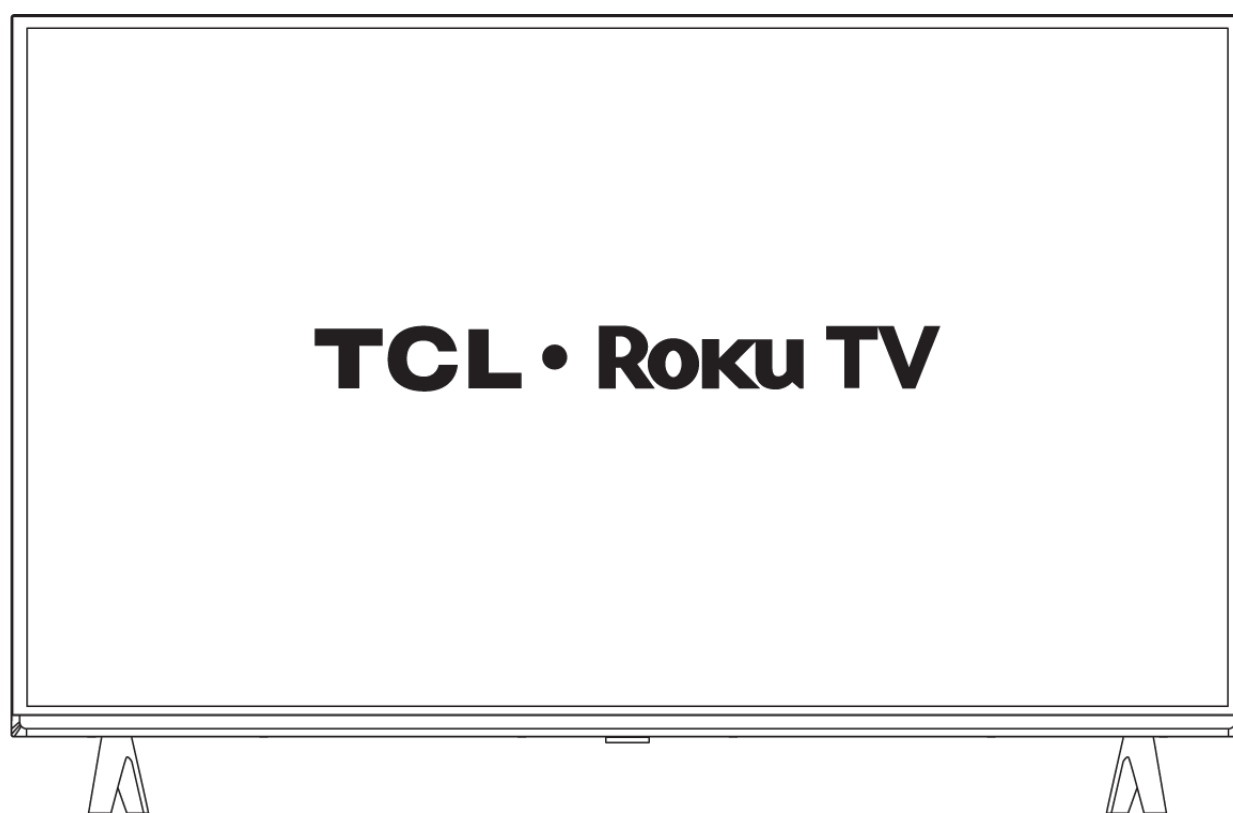

Illustrations in this guide are provided for reference only and may differ from actual product appearance.

## Trademark and copyright statement

© 2023 Roku, Inc. All rights reserved. ROKU, ROKU TV, ROKU TV READY, STREAMING STICK, STREAMBAR, the ROKU Logo, and the purple d-pad design are trademarks and/or registered trademarks of Roku, Inc. Material in this User Manual is the property of Roku, Inc., and is protected under US and International copyright and/or other intellectual property laws. Reproduction or transmission of the materials, in whole or in part, in any manner, electronic, print, or otherwise, without the prior written consent of Roku, Inc., is a violation of Roku, Inc.'s, rights under the aforementioned laws.

No part of this publication may be stored, reproduced, transmitted or distributed, in whole or in part, in any manner, electronic or otherwise, whether or not for a charge or other or no consideration, without the prior written permission of Roku, Inc.

Requests for permission to store, reproduce, transmit or distribute materials shall be made to the following address:

Roku, Inc.  
1155 Coleman Avenue,  
San Jose, CA 95110

Product name: Roku TV™

Document name: Roku TV™ User Guide

Document revision: 12.0 - United States, English

Publication date: 13 June 2023

# Contents

Welcome.....	1
The new standard in Smart TVs.....	1
Connecting brings out your TV's full potential.....	2
Take advantage of awesome features.....	3
What is streaming?.....	4
Connections and setup.....	6
Before initial setup.....	6
Protect against power surges.....	6
Safety information.....	6
Avoid audio interference.....	6
Avoid direct light.....	7
Set up your new TV.....	7
What's in the box.....	7
To use the stand.....	8
Optional - To mount on a wall.....	8
Connecting external equipment with a composite AV video cable (certain models).....	9
Connecting external equipment with an HDMI® cable.....	10
Connecting headphones or analog soundbar (certain models).....	11
Connecting an AV receiver or digital soundbar.....	11
Preparing for Internet connectivity.....	12
AC power.....	12
Roku remote batteries.....	13
Controls.....	14
Roku TV remote.....	14
Panel buttons.....	17
Guided Setup.....	19
Starting Guided Setup.....	19
Guided Setup.....	20
Network connection.....	22
Activation.....	27
Connect your devices.....	29
The Home screen.....	32
Customize your Home screen.....	33
Setting up live TV.....	34
How do I set up the TV tuner?.....	35
Using your TV.....	40
Status indicator.....	40
Standby mode energy savings.....	41
Opting in to Smart TV experience.....	41
Opting out of the Smart TV experience.....	42

Disabling Auto Notifications .....	42
Watching live TV channels .....	43
Changing channels.....	43
Using the Live TV Channel Guide.....	43
Navigating the Live TV Channel Guide.....	44
Using Live TV Categories .....	45
Changing channel options .....	47
Viewing program information.....	48
Adjusting settings while watching a program .....	48
Pausing live TV .....	49
Requirements .....	49
Enabling Live TV Pause.....	50
Using Live TV Pause .....	50
Notes about Live TV Pause.....	51
More Ways to Watch .....	52
Using More Ways to Watch.....	52
Getting the most from More Ways to Watch.....	54
Switching TV inputs.....	54
Auto-detecting devices.....	55
Auto-naming devices .....	55
Adjusting audio/video settings .....	55
Setting preferred audio language for streaming channels.....	55
Automatic game console configuration.....	56
Using Roku Voice commands.....	57
Using Roku Voice with Apple Siri.....	59
Using Roku Voice with Google Home .....	59
Using Roku Voice with Amazon Alexa .....	59
Using Roku Voice Remotes (certain models only).....	60
Connecting headphones to a Roku Voice Remote.....	60
Re-pairing your Roku Voice Remote .....	60
Checking the Roku Voice Remote battery level .....	61
Finding your Roku Enhanced Voice Remote or Roku Voice Remote Pro .....	61
Changing and previewing the remote finder sound.....	63
Playing content from USB storage devices.....	64
Auto player launch.....	64
Playing content from local network media servers .....	65
Setting up a payment method .....	65
Using your TV in a hotel or dorm room.....	66
About using your TV on a restricted public network .....	66
Connecting your Roku TV on a restricted public network .....	66
Using Apple AirPlay and the Apple Home app.....	69
Apple AirPlay .....	69
Other AirPlay things to try.....	69
Apple Home app .....	70
Some Apple HomeKit things to try.....	70

Adjusting TV settings .....	71
Main Settings menu.....	71
TV settings menu .....	73
Sleep timer .....	74
Picture settings .....	74
Fine tune picture menu options .....	76
Advanced settings menu options .....	77
Variable refresh rate (VRR).....	78
Sound settings.....	80
Dolby® Audio Processing (certain models only) .....	81
DTS® TruSurround / DTS® Studio Sound (certain models only).....	82
Sonic Emotion™ Premium (certain models only).....	82
Volume mode (certain models only).....	83
Roku premium audio products .....	83
Manage channels.....	84
Favorite channels .....	85
Edit channel lineup .....	86
Hide streaming TV channels .....	87
Accessibility & captions .....	87
Accessibility & captions menu settings .....	88
Video description through Secondary Audio Program (SAP).....	89
Picture off .....	89
Featured Free.....	90
Searching for something to watch.....	91
How do I search?.....	91
Voice Search from a Roku Voice remote.....	92
Searching from the Roku mobile app .....	92
Searching with Google Assistant .....	93
Searching with Amazon Alexa .....	93
Keyboard search using the remote.....	94
Direct-to-playback search results.....	94
Searching for free content .....	94
Using the Roku Store.....	95
Automatic Account Link.....	95
Customizing your TV .....	96
Add TV inputs to your Home screen .....	96
Add streaming channels to your Home screen.....	96
Rename inputs.....	97
Custom input names/icons.....	97
Remove unwanted inputs and channels.....	98
Rearrange inputs and channels.....	98
Change the look and feel with themes.....	99
Change menu volume .....	100
Configure power settings.....	101

Power on settings .....	101
Auto power savings .....	101
Standby LED On/Off .....	102
Fast TV start .....	102
Configure accessibility .....	103
Captions mode.....	103
Captions preferred language.....	103
Captions style.....	104
Screen reader settings.....	105
Customize the Home screen .....	105
Parental controls.....	106
Creating a parental control PIN .....	106
Blocking broadcast TV programs.....	107
Enabling parental control of TV programs.....	107
Blocking based on US TV ratings.....	108
Blocking based on US movie ratings.....	109
Blocking based on Other ratings.....	109
Blocking based on Canadian English ratings.....	110
Blocking based on Canadian French ratings .....	111
Blocking unrated programs.....	112
What happens when a TV program is blocked? .....	113
Changing your PIN .....	114
Resetting parental controls.....	115
More settings .....	116
Guest Mode.....	116
Network settings.....	118
ZIP Code.....	119
Time settings.....	119
Scan again for live TV channels .....	120
Control by mobile apps.....	121
Changing privacy settings .....	122
Advertising .....	122
Voice.....	123
Smart TV experience .....	124
Roku TV soundbars and wireless speakers .....	125
Roku wireless speakers .....	126
Setting up Roku wireless speakers .....	126
Checking Roku Soundbar or Roku Speaker software version.....	126
Factory resetting a Roku soundbar or Roku speakers from the TV.....	127
Home theater configuration.....	128
Controlling audio output.....	128
Wall-mounted TV .....	129
Setting up a digital audio connection.....	129
Choosing a preferred audio streaming format .....	130
Choosing an audio digital output format.....	130

Dolby Atmos notification.....	131
Adjusting audio delay.....	131
Turning off the TV screen while listening to music.....	132
Controlling other devices through CEC .....	132
Restart the TV.....	133
Reset the TV.....	134
Reset audio/picture settings .....	134
Factory reset everything .....	134
What if I can't access the Factory Reset option?.....	135
Using Recovery Mode .....	135
Network connection reset.....	135
Roku Account PIN .....	136
Update the TV .....	136
Using other devices with your TV .....	138
Using Bluetooth® private listening (certain models) .....	138
Pair your Bluetooth headphones .....	138
Connect your Bluetooth headphones .....	139
Disconnect your Bluetooth headphones .....	139
Disable Bluetooth auto detect.....	140
Pairing your phone, tablet, or computer with Bluetooth® .....	140
Pair your device .....	140
Connect your device and play audio on your TV.....	141
Disconnect your device.....	142
Mirroring your phone or tablet.....	142
Roku mobile app .....	143
Private Listening on the Roku mobile app .....	144
Using a universal remote.....	144
What if I didn't connect my TV?.....	145
What you're missing by not connecting.....	145
Managing live TV channels when your TV is not connected .....	147
Designating favorite channels.....	147
Surfing only favorite channels.....	147
Editing the channel lineup.....	148
Connecting your TV.....	149
Updating a TV that is not connected.....	149
FAQ .....	152
Other information.....	153
FCC Information.....	153
<b>Battery CAUTION &amp; Disposal Information</b> .....	153
Electronics & Packaging Recycling Information .....	154
Care and Cleaning .....	154
Television Specifications.....	155
Notices .....	156





# Welcome

Congratulations on the purchase of your new Roku TV™! Discover the joy of endless entertainment. After it's set up, you'll be able to access a world of streaming entertainment, including paid subscription channels and thousands of free channels.

**Important:** When you connect your TV to the Internet and link it to a Roku® account, your TV receives automatic updates from time to time, enabling new content and features. This edition of the User Guide describes Roku TV version 12.0. To determine the current version of your Roku TV, go to **Settings > System > About**. Note also that some features of the TV might change from time to time independently of Roku TV updates.

## The new standard in Smart TVs

Welcome to TV like you've most likely never seen before—a home screen that you can personalize with your favorite devices and streaming channels. Choose from hundreds of thousands of movies and TV episodes, plus content genres such as music, sports, kids, family, international and much more. You should never run out of things to watch.

**Note:** A paid subscription or other payments may be required for some channel content. Channel availability is subject to change and varies by country.

# Connecting brings out your TV's full potential

Connecting to a new or existing Roku account is free. It's easy, and unlocks a world of entertainment. All you need is a network connection. Stream a massive selection of free, live, and premium TV.

## Make any night a movie night

Thousands of movies to choose from, across all major streaming movie channels<sup>1</sup>.

## Check out The Roku Channel

Use The Roku Channel as your new home page for an ever growing assortment of free on-demand and streaming movies, programs, live news, and kid's TV. Use the Live TV Channel Guide within The Roku Channel or while watching Live TV from your antenna or cable connection. Add premium subscriptions to watch many of your favorite channels in one place, and manage them all through your Roku account.

## Get in the groove

Stream endless hours of music from free and subscription-based channels. With almost instant access to thousands of music artists, your favorite beats are just as close as your remote.

## Explore your passions

In addition to the most popular streaming channels, your Roku TV also offers hundreds of other streaming channels to fuel your passions—including fitness, cooking, religion, outdoors, international programming and much more.

---

<sup>1</sup> A paid subscription or other payments may be required for some channels. Channel availability is subject to change and varies by country. Not all content is available in countries or regions where Roku® products are sold.

# Take advantage of awesome features

**Powerful, voice-enabled search** lets you use voice commands to find movies and TV programs by title, actor, director, or genre across multiple streaming channels<sup>1</sup>. Additionally, your search commands can include popular movie quotes, and words like “free” and “4K.” In addition to streaming channels, your search results include live TV programs airing in your region. If you don’t have a Roku voice remote, use an on-screen keyboard or the Roku mobile app to search. Find any movie, show, song, or podcast across thousands of channels. You’ll see where it’s streaming for free or at the lowest cost.

**Voice commands with multiple device support** let you use Apple Siri, Google Assistant, or Amazon Alexa to change stations, TV inputs, launch streaming channels, and more. Use conversational commands and, if needed, include a location in your command such as “in the bedroom” to specify which Roku device you want to control.

**Apple AirPlay 2** lets you use your iOS and macOS devices to effortlessly share videos, photos, music, and more on Roku TVs<sup>2</sup>. Control AirPlay sessions with pause, rewind, and more using your iPhone, iPad, or Mac. Play music from your Apple devices on Roku TVs and other AirPlay 2 enabled speakers in your home at the same time in perfect sync. Plus, mirror the screen from your iPhone, iPad, or Mac to the big screen.

**Live TV Pause** (certain models only) uses a USB thumb drive (not provided) to let you pause live TV for up to 90 minutes. After pausing, you can play, fast-forward, rewind to any point within the rolling 90-minute window.

**Note:** Live TV Pause is available on digital TV programs received on the **ANT** input.

**Live TV Channel Guide** is an electronic program guide that includes both broadcast TV channels and live streaming channels. Use the guide whenever you are watching Live TV or after selecting the Live TV Channel Guide within The Roku Channel.

**Screen mirroring** can send your personal media to the big screen from your compatible smartphone or tablet in just a few taps. Plus, with certain channels, you can send movies, programs, sport highlights, and more directly to your TV.

---

<sup>1</sup> Voice features support English, Spanish, Portuguese, and German languages.

<sup>2</sup> Apple AirPlay 2 and HomeKit are supported by all Roku TVs except models beginning with “6” (6XXXX) and “5” (5XXXX). Your TV’s model number appears as the Hardware ID found under **Settings > About**.

**Private Listening** (only on models that include an Enhanced Voice Remote or Roku Voice Remote Pro) means you can listen to streaming programs and “over-the-air” TV programs from a headphone jack on the side of the remote.

**Free Roku mobile app** for iOS<sup>®</sup> and Android<sup>™</sup> mobile devices<sup>1</sup> gives you even more exclusive features, such as:

- A second, more powerful remote control. Browse channels and search more easily using your mobile device’s touch keyboard. Use Roku Voice commands to search and control your TV, even if it does not have a Roku Voice Remote.<sup>2</sup>
- Experience private listening even if your TV does not have a Roku Voice Remote. Listen to TV audio through either wired or Bluetooth<sup>®</sup> headphones connected to your mobile device.
- Use Play on Roku to play your videos, photos, and music on your TV.
- Create a screensaver from your photo library to show whenever your TV has been inactive for an extended period of time.

**Customizable Home screen** puts your favorite streaming channels and TV inputs front-and-center. Choose your own wallpaper and screensaver to customize your Roku TV, and configure your channels and inputs just how you want them.

**Automatic account linking** keeps track of supported streaming subscriptions on other Roku devices, so that you won’t have to re-enter your user name and password when adding the same channel on your newly-activated Roku TV.<sup>3</sup>

## What is streaming?

Streaming is viewing or listening to video or audio content that is sent over the Internet, or located on a network-connected media server.

With streaming, you can buy or rent most programs on demand, when it’s convenient for you, and you can also watch live streaming channels and events. Also, you can play, pause, rewind, and fast forward most on-demand streaming programs.

---

<sup>1</sup> iOS<sup>®</sup> is a trademark or registered trademark of Cisco in the U.S. and other countries and is used under license. Android<sup>™</sup> is a trademark of Google Inc.

<sup>2</sup> Voice features support English, French, Spanish, Portuguese, and German languages.

<sup>3</sup> Not all streaming channels currently support automatic account linking.

**Tip:** Some content cannot be paused or skipped. For example, if you are viewing live programming or a program that is supported by ads, you might not be allowed to skip the ads.

Your Roku TV lets you choose from thousands of streaming channels that offer a huge selection of entertainment:

- Thousands of movies and TV episodes, both live and on-demand
- Unlimited music, live and on-demand
- Tons of live and on-demand sports
- Commercial-free programming for kids and family
- International programming in 22 languages
- 24x7 news and in-depth news commentary

Many streaming channels are free. Some streaming channels let you purchase or rent the latest movie releases or popular TV series. Some channels charge a monthly subscription fee and others are available at no additional cost if you subscribe to a companion service through your cable or satellite provider.

If you have an existing subscription to a streaming provider, you can just sign in with your existing user name and password.

To play streaming content, add one or more streaming channels to your Home screen. Use the **Streaming Channels** option on the Home Screen Menu to go to the Roku Store, and then select the streaming channel you want to add. The channel remains on your Home screen unless you remove it, and you can watch it at any time.

For more information, see [Using the Roku Store](#).

**Note:** A paid subscription or other payments may be required for some channels. Channel availability is subject to change and varies by country. Not all content is available in countries or regions where Roku® products are sold.

Let's get started.

# Connections and setup

Refer to your TV's Quick Start Guide or other provided documentation for model-specific information about attaching the base or a wall mount and making connections to AC power and to your other audio/video devices.

## Before initial setup

### Protect against power surges

- Connect all components before you plug any power cords into the wall outlet or power strip.
- NEVER plug your TCL Roku TV into an outlet that is controlled by a wall switch.
- Turn off the TV before you connect or disconnect any cables.
- Make sure all antennas and cables are properly grounded. Refer to the Important Safety Instructions.

### Safety information

- Prevent TV from overheating by placing in an area with good ventilation.
- Do not block ventilation holes on the TV. Position the TV so air can circulate freely on all sides.
- Do not stack objects on the TV.
- If you place the TV on a stand, make sure you allow adequate ventilation.
- If you connect an audio receiver or amplifier to the TV, place it on the top shelf so the heated air will not overheat the TV.

### Avoid audio interference

- Position cables properly; insert each cable firmly into the designated jack.
- Route all cables down one side of the back of the TV instead of straight down the middle.
- If your antenna uses 300-ohm twin lead cables, do not coil the cables.
- Keep twin lead cables away from audio/video cables.

## Avoid direct light

Do not place the TV where sunlight or room lighting is directed toward the screen. Use soft or indirect lighting.

## Set up your new TV

**Warning:** To avoid the danger of suffocation, keep plastic packaging away from pets, babies, and children. Do not use packaging bags in cribs, beds, carriages, or playpens.

Open the box and remove the TV and other items. Be careful, the TV is heavy! We strongly recommend that two people unbox the TV.

Be sure to check all the foam packaging as the stands from some TV's are stored in the foam for protection.

### What's in the box

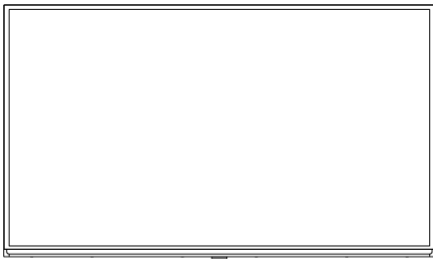

TCL Roku TV

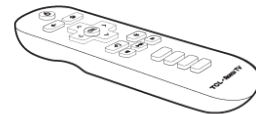

TV remote

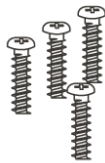

32": ST4X20mm  
40"/43": ST4X25mm

4 x Stand screws

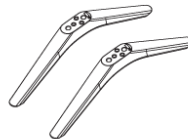

TV stands

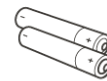

2 x AAA batteries  
for remote

## To use the stand

Your TCL Roku TV comes without the stands attached so that you can choose to use the stands or mount your TV to a wall using a wall mount (sold separately). If you want to mount your TV to the wall, don't attach the stand legs.

**A** - To prevent damage to the screen, carefully place your TV on a soft, cushioned surface.

**B** - Put the column of the stands into the TV, align the stands with the screw holes located on the TV. Secure the stands to the TV with four (4) screws.

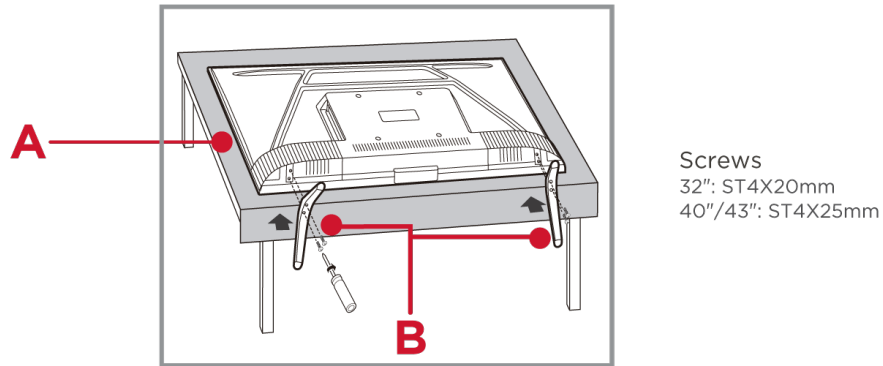

Refer to your TV's Quick Start Guide or other provided documentation to for model-specific information about attaching the base or a wall mount and making connections to AC power and to your other audio/video devices. The following information applies to all TCL • Roku TV models.

## Optional - To mount on a wall

(wall mount not included)

**Warning:** *This product should only be mounted by a professional installer.*

**Warning:** **Never install or mount** this product to the ceiling with the screen side facing down. Installing or mounting this product to the ceiling or the underside of a structure or surface is hazardous and may result in personal injury and/or property damage.

### To mount on a wall

Preparation must be done before mounting your TV on a wall.

If you are mounting your TV to the wall, don't attach the stands.

- **32" model** VESA 100x100, 4 M4x10mm screws
- **40" model** VESA 100x100, 4 M6x12mm screws
- **43" model** VESA 100x100, 4 M6x12mm screws

The VESA number is the horizontal and vertical measurement of the mounting holes. For example, 100X100 refers to the fact that the mounting measurements are 100mm horizontally and 100mm vertically.

Follow the instructions that come with the wall mount.

Your wall mount must be able to bear a minimum of five times the TV's net weight to avoid causing damage.



## Connecting an antenna, cable, or satellite box

If you are using an antenna, CATV cable without a set-top box, or a cable or satellite box that has only an antenna output, connect a 75-ohm coaxial cable (not provided) from the source to the **ANT/CABLE** input on the TV.

**Tip:** If you are using an antenna with a 300-ohm twin-lead cable, you need to use a 300-to-75-ohm adapter (not provided) to adapt the twin-lead cable to a connection that is compatible with the TV's antenna input.

**Tip:** If you receive your TV stations through a set top box from a cable or satellite TV provider, connect it to the TV using the best connection method available:

- **HDMI<sup>®</sup> input** - Digital HD and SD video
- **AV input** (certain models only) - analog SD video
- **Antenna input** - SD video using NTSC/ATSC

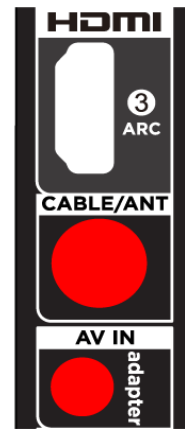

## Connecting external equipment with a composite AV video cable (certain models)

Only on certain models, connect a device to the TV using a composite AV cable (not provided). Composite AV cables typically have three RCA-type plugs on each end, color coded as follows:

- **Yellow** - Video
- **Red** - Audio, right channel
- **White or black** - Audio, left channel

Connect each plug to the corresponding connector on the device and on the TV.

## Connecting external equipment with an HDMI® cable

If possible, connect your devices using HDMI® cables (not provided). They help to provide the best video quality and also carry audio signals, so that only one cable is needed. For better picture quality, we recommend that you use cables designated as High Speed HDMI® Cables.

**Tip:** You might need to configure the device to send its signal through its HDMI® connector.

The connector labeled **HDMI (ARC)** has the additional ability to use the audio return channel to send digital audio to a receiver or soundbar, as explained in [Connecting an AV receiver or digital soundbar](#). Only on certain models: The connector labeled **HDMI (eARC)** provides the same functionality as the **HDMI ARC** connector, plus the ability to pass through full-resolution sound formats such as Dolby Atmos® and DTS:X from and to devices that support these formats, without additional processing by the TV. Additional details are provided in [Choosing an audio digital output format](#).

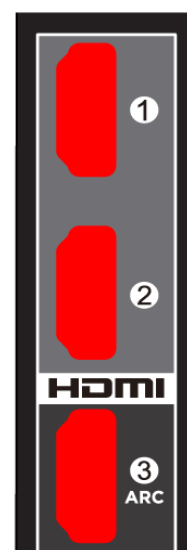

## Connecting headphones or analog soundbar (certain models)

Only on certain models, you can connect headphones or an analog soundbar (not provided) to the TV's headphone jack.

**Tip:** Inserting a plug in the headphone jack disables the sound from the TV's built-in speakers.

**Warning:** Loud noise can damage your hearing. When using headphones, use the lowest volume setting on your headphones that still lets you hear the sound.

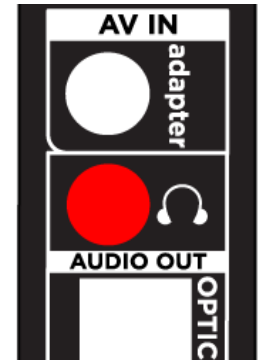

Certain models also have an audio line out connection that is not affected by TV volume or mute settings and does not disable the TV speakers. Use this connection when you want to use your amplifier or soundbar to control the TV volume. To turn off the TV's built-in speakers, from the Home Screen Menu, navigate to **Settings > Audio > TV speakers** and change the setting.

## Connecting an AV receiver or digital soundbar

You can enjoy Dolby Audio™ multichannel sound from your TV if you connect a digital amplifier or soundbar (not provided) in any of the following ways:

- **Digital optical audio out (S/PDIF)** – Connect a TOSLINK optical cable (not provided) from the TV to the Optical input on your receiver or soundbar.
- **HDMI® ARC** – Connect an HDMI® cable (not provided) from the **HDMI (ARC)** connector to the HDMI® input on your receiver or soundbar. This connection uses the Audio Return Channel (ARC) feature of HDMI® to output sound from the TV to a compatible device. To use this feature, you must configure the TV to enable HDMI® ARC, as explained in [Setting up a digital audio connection](#).



**HDMI® eARC** – Certain models only: Connect an HDMI® cable (not provided) from the **HDMI (eARC)** connector to the HDMI (ARC) or HDMI (eARC) input on your receiver or soundbar. If your receiver or soundbar supports HDMI enhanced ARC (eARC), the TV

can pass through full-resolution sound from programs containing enhanced audio. If your receiver or soundbar does not support eARC, use the TV's eARC port to make the connection to the device's ARC port. The eARC port is backward compatible with the ARC standard.

## Preparing for Internet connectivity

Your TV has a built-in wireless LAN adapter. Note that for wireless connectivity, your TV supports only its internal wireless network adapter—it does not support the use of a USB network adapter.

Some models have both wired and wireless network connectivity. To use the wired network connection if available on your TV, connect an RJ-45 Ethernet cable (not provided) from the jack on the back of your TV to your network router or switch. The wired connection automatically supports both 10 Base-T and 100 Base-T Ethernet.

## AC power

Plug your TV into a power outlet. You can tell that the TV has power because the status indicator lights up when the TV is off.

The topic [Status indicator](#) explains how the status indicator shows what is happening with the TV.

# Roku remote batteries

Review the [Battery Caution & Disposal Information](#) on page 153

Open the back of your Roku remote and insert the included batteries, observing the proper orientation as indicated in the battery compartment. Reattach the back cover.



# Controls



## Roku TV remote





Use the following information to identify the buttons on your Roku remote.

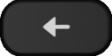







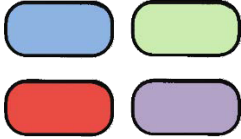

**Note:** Remote buttons and features vary somewhat by model. Your remote might not have all buttons or features listed.

- If your remote has a **VOICE**  button just below the purple pad, you have a Roku Voice Remote.
- If your remote has a headphone jack on its left edge, you have a Roku Enhanced Voice Remote or Roku Voice Remote Pro.

Roku Voice remotes have additional capabilities as noted in the following table.

BUTTON	FUNCTION	DESCRIPTION
	<b>POWER</b>	Turns TV on and off.
	<b>BACK</b>	<b>Menu:</b> Goes back to previous menu/screen. <b>Watching live TV or a TV input:</b> Returns to Home screen. <b>Playing streaming content:</b> Stops playing stream and returns to the previous menu or screen. <b>Browsing streaming content:</b> Goes to the previous level in the content tree.
	<b>HOME</b>	Immediately returns to the Home screen.

BUTTON	FUNCTION	DESCRIPTION
	<b>DIRECTIONAL PAD</b>	<p>Arrows move the highlight in the corresponding direction. <b>OK</b> chooses the highlighted option.</p> <p>While watching TV:</p> <p><b>UP/DOWN</b> changes channel.</p> <p><b>LEFT</b> displays Live TV Channel Guide.</p> <p><b>LEFT/RIGHT</b> In the channel list switches between ALL CHANNELS and FAVORITE CHANNELS.</p> <p>If Live TV Pause enabled: When program is paused, jumps backward/forward approximately 10 seconds.</p> <p><b>OK</b> In the channel list, selects the highlighted channel. While watching live TV, displays program information.</p>
	<b>VOICE</b> or <b>SEARCH</b>	<p>Only on models with Roku Voice remotes, initiates Roku Voice. Hold down the button and use your voice to control the TV and search for content. For more information: <a href="https://www.roku.com/voicesearch">go.roku.com/voicesearch</a></p>
	<b>REPLAY</b>	<p><b>Live TV:</b> Jumps to previously tuned channel. If Live TV Pause is enabled, jumps back a few seconds with each press and resumes playing.</p> <p><b>Program guide:</b> Returns to the current day and time.</p> <p><b>Streaming content:</b> Depends on the streaming channel.</p> <p><b>On-screen keyboard:</b> Backspaces in the text you are entering.</p>
	<b>◀◀ REWIND</b> <b>▶▶ PLAY/PAUSE</b> <b>▶▶▶ FAST FWD</b>	<p>Scan backward, pause, play, and scan forward in streaming content and (if Live TV Pause is enabled) in live TV channels.</p> <p>Press <b>REWIND</b> ◀◀ or <b>FAST FWD</b> ▶▶▶ one, two, or three times to control the speed of the operation.</p> <p><b>Note:</b> <b>REWIND</b> ◀◀ and <b>FAST FWD</b> ▶▶▶ also page through long lists such as the channel list or Live TV Channel Guide.</p>
	<b>STAR</b>	<p>Displays additional options when available. On-screen hints let you know when this button is active.</p>

BUTTON	FUNCTION	DESCRIPTION
	<b>GAME MODE</b>	Certain models. Only on <b>HDMI</b> and <b>AV</b> inputs, turns Game mode on or off. When <b>On</b> , the TV does less image processing, producing lower input lag for action games
	<b>SLEEP</b>	Certain models. Cycles among preset sleep time intervals and displays the remaining sleep time, if any.
	<b>FACTORY ASSIGNED CHANNEL SHORTCUT</b>	Dedicated buttons show the logo of a preset streaming content provider. Dedicated content providers vary by model and region. Pressing a button turns on the TV and also does the following: <ul style="list-style-type: none"> <li>• Displays the streaming channel's main page if you have already added the channel to your Home screen.</li> <li>• Displays the streaming channel's sign-up page if you have not already added the channel.</li> </ul>
	 <b>UP</b>  <b>DOWN</b>  <b>MUTE</b>	Located on the right edge of the remote. Increases/decreases volume and mutes the TV sound.
	 <b>HANDS-FREE VOICE</b>   <b>HEADPHONE</b>	<p>Certain models with Roku Voice Remote Pro. Located on the left edge of the remote. Turn on to enable issuing commands by saying, "Hey, Roku" followed by your voice command, in place of using the <b>VOICE</b> button.</p> <p>Certain models with Roku Enhanced Voice Remote or Roku Voice Remote Pro. Located on the left edge of the remote. Connect headphones to listen privately. Plugging in headphones mutes the TV speakers.</p>



# Panel buttons

Your TV has buttons on the side, bottom, or back panel that perform simple control functions. The TV panel buttons are not a substitute for the remote, as they do not give you access to all TV functions. The panel button(s) on some models might be difficult to find. If the location is not obvious, check the bottom center of the TV behind the status indicator LED, or the back panel of the TV near the lower right or left side.

Different TV makes and models have different panel button designs. Choose the one that applies to your TV from the following list:

BUTTON DESIGN	FUNCTION	OPERATION
Single button	Power on	Short press (less than 2 seconds)
	Power off	Long press (more than 2 seconds)
	Input List	Short press when TV is on
	Select next input	Short press while Input List displayed, then wait
	Dismiss input list	No press (wait)
Three buttons	Power off	Middle button, short press (less than 2 seconds)
	Input List	Middle button, long press (more than 2 seconds)
	Select next input	Right button when Input List is not displayed
	Dismiss input list	Left button when Input List is not displayed
	Input List	Middle button, short press when TV is on
	Highlight next input	Right button while Input List is displayed
	Highlight previous input	Left button while Input List is displayed
Select highlighted input	Middle button (or wait)	
Game pad style (5 buttons)	Power on/off	Middle button
	Increase/decrease volume	Up/down button
	Input List	Left/right button
	Select input	Left/right button while Input List is displayed, then wait
Four discrete buttons	Power on/off	POWER
	Input List	INPUT
	Select next input	INPUT while Input List is displayed, then wait
	Volume up	VOLUME +
	Volume down	VOLUME -

BUTTON DESIGN	FUNCTION	OPERATION
Five discrete buttons (with mute)	Power on/off	POWER
	Input List	INPUT
	Select next input	INPUT while Input List is displayed, then wait
	Volume up	VOLUME +
	Volume down	VOLUME -
	Mute	MUTE
Five discrete buttons (without mute)	Power on/off	POWER
	Input List	INPUT + or INPUT -
	Select next input	INPUT + while Input List is displayed, then wait
	Select previous input	INPUT - while Input List is displayed, then wait
	Volume up	VOLUME +
	Volume down	VOLUME -
Seven discrete buttons	Power on/off	POWER
	Next channel	CHANNEL + while viewing a Live TV channel
	Previous channel	CHANNEL - while viewing a Live TV channel
	Input List	INPUT
	Select next input	INPUT or CHANNEL + while Input List is displayed, then wait
	Select previous input	CHANNEL - while Input List is displayed, then wait
	Volume up	VOLUME +
	Volume down	VOLUME -
	Mute	MUTE

# Guided Setup

With the preliminaries out of the way, it's time to turn on your TV. As the TV starts for the first time, it leads you through Guided Setup, which configures the TV before you start to use it.

During Guided Setup, you'll:

- Answer a few questions
- Provide network connection information
- Get a software update
- Link your TV to your Roku account.
- Connect devices such as a DVD player, game console, or cable box.

## Starting Guided Setup

To start Guided Setup, press **POWER**  on the remote to turn on your TV.

**Note:** Guided Setup normally runs only once, the first time you turn on your TV. If you need to run Guided Setup again, you must perform a factory reset as explained in [Factory reset everything](#).

When you first turn on your TV, it will take a few seconds to get itself ready. You'll notice the following things happening:

- The status indicator blinks every time the TV is busy doing something; in this case it's powering up and getting ready for you.
- A startup screen appears and the status indicator blinks slowly for a few more seconds. The startup screen shows a TV brand logo while the TV gets ready.





After a few seconds, Guided Setup starts.

## Guided Setup

At this point, you should be seeing the **Language** screen.



1. Only on models that have a Roku Voice remote: A few moments after the **Let's get started screen** appears, Guided Setup starts the pairing process for the Roku Voice remote. (You'll know if you have this type of remote because it has a **VOICE**  or **SEARCH**  button just below the purple directional pad.) If the Roku Voice remote does not pair automatically, follow the instructions on the screen to complete the pairing process.

**Accessibility:** If you have selected *English* language, you can activate the screen reader, a text-to-speech screen reader to help you navigate the TV's menus and commands. To enable the screen reader, press **STAR \*** four times in rapid succession. Repeat to disable the screen reader. (**STAR \*** is located directly below the purple directional pad on the right side of the Roku remote.)

If you enabled the screen reader, choosing any language other than English disables it.

2. Press **DOWN** on the purple directional pad to highlight your preferred language, and then press **OK**.
3. Some models have a country selection screen: If you don't see this screen, skip ahead to the next step.

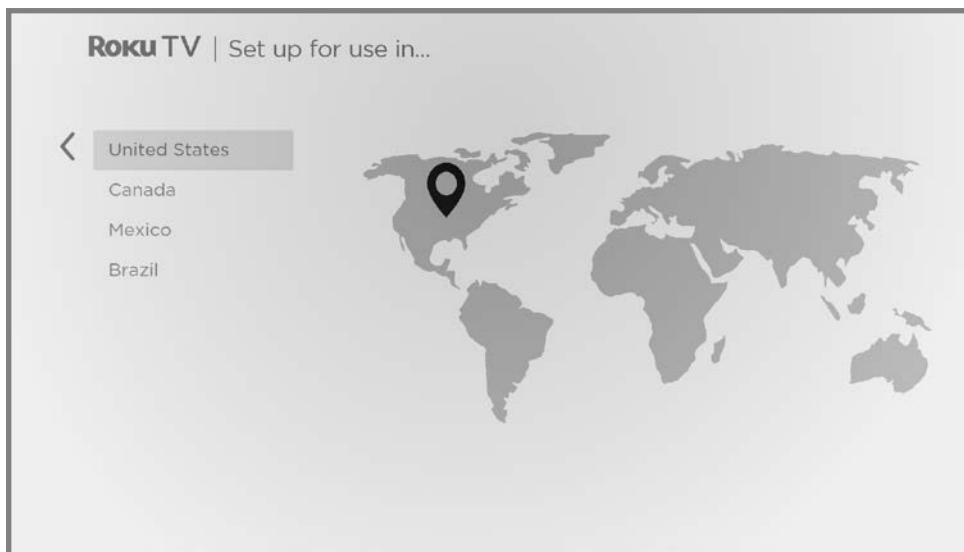

If you see this screen, select your country, and then press **OK**.



4. Press **OK** to select **Set up for home use**. This is the right choice for enjoying your TV at home. It provides energy saving options as well as access to all features of the TV.

**Note:** *Set up for store use* configures the TV for retail display and is not recommended for any other use. In store mode, many features of the TV are missing or limited. To switch from one mode to the other, you have to perform a factory reset as explained in [Factory reset everything](#), and then repeat Guided Setup.

## Network connection

After you select **Set up for home use**, the TV prompts you to make a network connection. If your TV has both wired and wireless connections, you'll see the following screen. If your TV has only wireless connectivity, skip the following step.

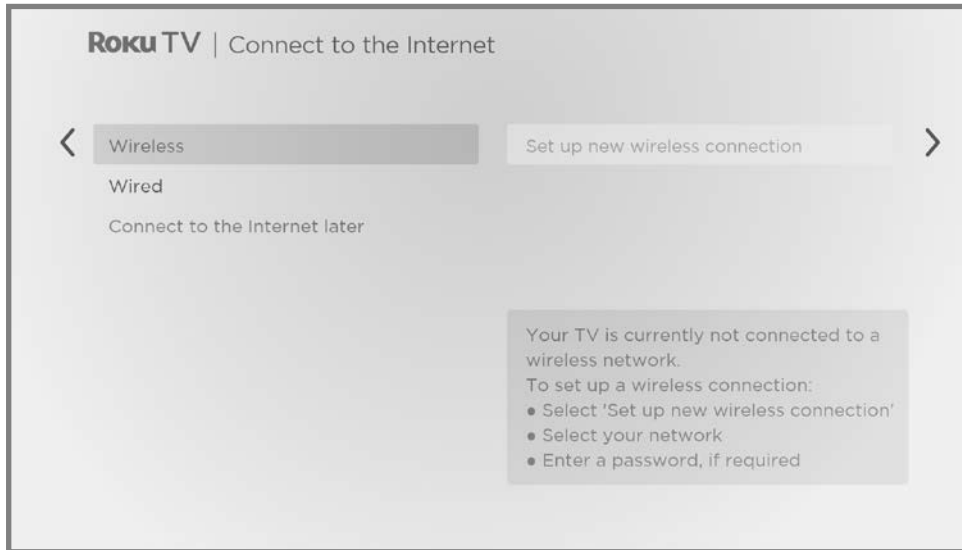

5. Only on models that display the *Connect to the Internet* screen: Make a selection:
- **Wireless connection** – Highlight **Set up new wireless connection** and press **OK**. The TV prompts you through wireless setup. Skip ahead to the next step for help with the process.
  - **Wired connection** – Highlight **Connect to wired network** and press **OK**. The TV immediately attempts to connect to your wired network, your local network, and then the Internet. Go to Step 9 to continue with Guided Setup.
  - **Connect to the Internet later** (Only on certain models) – Select this option to skip connecting to the Internet. You can still use the TV to watch live TV channels, and connect your devices to play games, watch DVDs, or watch content from a cable box or another streaming device. When you're ready to connect, it's easy. We'll show you how in [What if I didn't connect my TV?](#)

**Note:** If you decide not to connect to the Internet, Guided Setup skips ahead to setting up the devices that you've connected to your TV. Jump ahead to [Connect your devices](#) to complete Guided Setup.

6. On wireless-only models or models with both wired and wireless and you've selected **Wireless**, the TV scans for the wireless networks within range and displays them in order, with the strongest signals first. In addition to your own wireless signal, the TV might pick up signals from your neighbors.

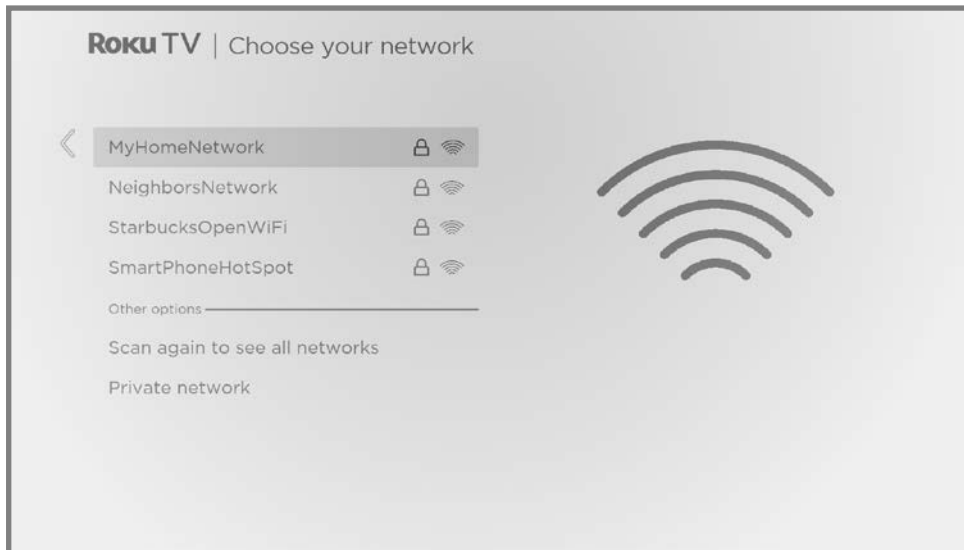

Press **UP** or **DOWN** to highlight the name of your wireless network, and then press **OK** to select it.

**Note:** Some networks, such as those often found in dorm rooms, hotels, and other public places, require you to read and agree to terms, enter a code, or provide identifying information before letting you connect to the Internet. If your Roku TV detects that you are connecting to such a network, it prompts you through the connection process using your smartphone or tablet to provide the needed information. For more information, see [Using your TV in a hotel or dorm room](#).



## Other options

- **Scan again / Scan again to see all networks** – The name of this option depends on the number of wireless networks within range.
  - **Scan again** appears if the list already shows all available wireless networks within range. If you don't see your wireless network name in the list, you might need to adjust the location of your wireless router or the TV, turn on your router, or make other changes. When everything is ready, select **Scan again** to see if your network name now appears in the list.
  - **Scan again to see all networks** appears only if there are more wireless networks than the ones initially listed. If you don't see your wireless network name in the list, this option displays the complete list. If you still don't see your network name, you might have your router configured to provide wireless service as a “private network.”

**Note:** Highlighting either of these options displays an informational panel with the unique media access control (MAC) address of your Roku TV. You will need the MAC address if your wireless router is configured to use MAC address filtering.

- **Private network** – If your wireless network name is hidden, it won't appear in the list. Select **Private network** and then press **OK** to display an on-screen keyboard. Use the keyboard to enter your network name. Unless you changed the factory-set network name, you can find the name (also called SSID) on a label on the router.

**Tip:** Wireless networks that are password-protected display a “padlock” icon adjacent to the name. This icon enables you to know that you are going to be prompted to enter a password after you select that network.

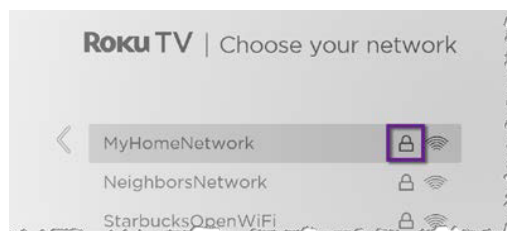

- Unless you are connecting to an open wireless network, an on-screen keyboard appears. Enter your wireless network password by using the purple directional pad to navigate the keyboard and pressing **OK** to select a highlighted letter, number, or symbol. When you finish, press **DOWN** to select **Connect**, and then press **OK**.

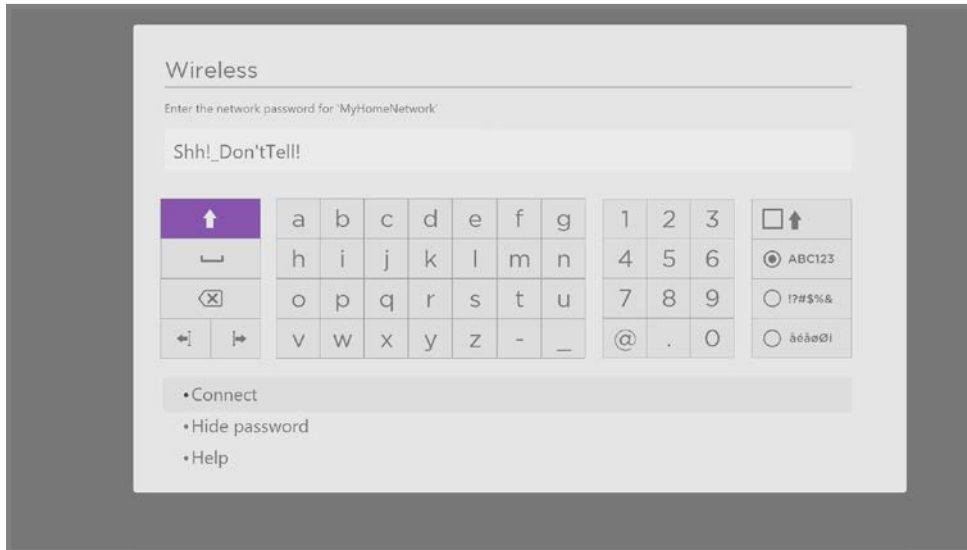

After you select **Connect**, the TV displays progress messages as it connects to your wireless network, your local network, and the Internet.

- Only if your TV cannot get the correct time zone and current time from your network service provider: The **Choose your time zone** screen appears. Press **UP** or **DOWN** to highlight your time zone, and then press **OK**.



**Tips:** Your TV needs to know the local time zone so that it can correctly display information about the program you are currently watching.

Your TV automatically checks for updates periodically. These updates provide new features and improve your overall experience with the TV. After an update, you might notice that some options have moved, and that there are new options or features. This User Guide describes version 12.0. But note also that certain features of the TV might change from time to time independently of Roku TV updates.

To determine your current Roku TV software version, go to **Settings > System > About** after you complete Guided Setup. You can download an updated User Guide for the latest software version from the Roku TV web site at:

[go.roku.com/tvmanual](http://go.roku.com/tvmanual)

## Activation

After the TV restarts, it prompts you through activation. Note that you may need to supply your email address to activate your TV.

9. To begin the activation process, enter your email address on the TV when prompted.
10. To complete the activation process, use a computer, tablet, or smartphone with an Internet connection to receive and acknowledge the email from Roku, and then follow the instructions on that device to link to a new or existing Roku account.

**Note:** Roku does not charge for activation support - **beware of scams**. For detailed information, see the Roku support article, [How to protect yourself from activation and technical support scams](#)

---

## Why do I need a Roku account?

You need a Roku account for several reasons:

- It links you, your Roku TV, and your other Roku streaming devices to the Roku Store and billing service.
- Streaming content providers know that it's OK to send content you request to your Roku TV.
- Roku can automatically update your TV with the latest features.

You need a Roku account to activate your device and access entertainment across thousands of streaming channels. Linking to a Roku account also activates several advanced features on your TV, such as Guest Mode, the Roku mobile app, and Live TV Pause, to name just a few. Roku accounts are free. Providing payment information during signup makes renting, purchasing, and subscribing to entertainment from the Roku Store fast and convenient.

---

After you activate your TV, it gets an acknowledgement from Roku and then adds your newly-selected and pre-existing streaming channels from other Roku devices on the same account. This process is automatic and takes a few moments—a little longer if you have added a lot of streaming channels.

**Tip:** Roku periodically synchronizes streaming channels among all of the devices associated with your account. Therefore, adding or removing a channel from one of your Roku devices adds or removes it from all of your other Roku devices (subject to compatibility with the device).

## Connect your devices

Next, Guided Setup helps you set up the external devices that you want to use with it, such as a cable box, Blu-ray™ player, or game console.



11. Press **OK** to proceed:

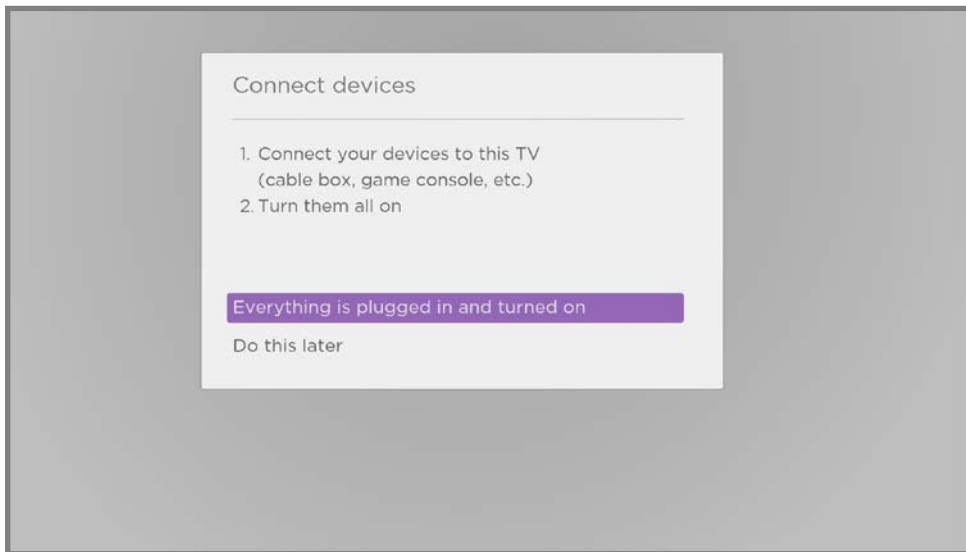

12. Connect all the devices you plan to use with your TV, turn them all on, and then select **Everything is plugged in and turned on**. The TV now takes you step by step through each of its inputs and asks what kind of device you have connected. For each input that has a connected and active device, you can see its picture and hear its sound.

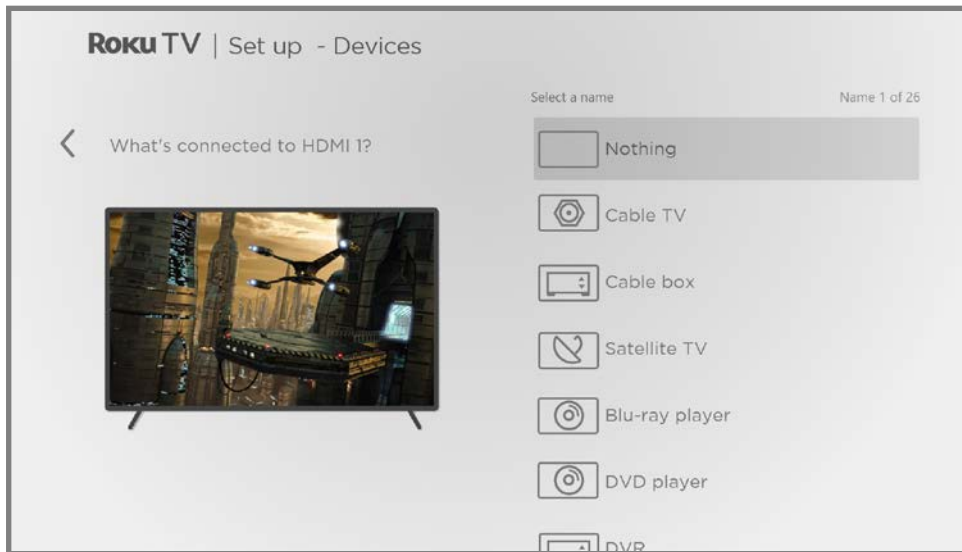



13. Press **UP** or **DOWN** to highlight the label you want to associate with the input, and then press **OK**. If you are not using the input, select **Nothing**, and the input won't appear on the Home screen.
14. While setting up your devices, rather than using the predefined names and icons, you can set a custom name and icon. To do so, scroll up or down to highlight **Set name & icon**, and then press **OK**. Follow the instructions on the screen to enter a name and select an icon for the input. See [Rename inputs](#) for more information.

**Note:** If you specify a custom name for an input, voice commands will not reliably switch to that input. Voice commands typically can only switch among inputs that use built-in names, such as “AV,” and “Cable Box,” and “DVR.”

15. Repeat the previous step for each input.

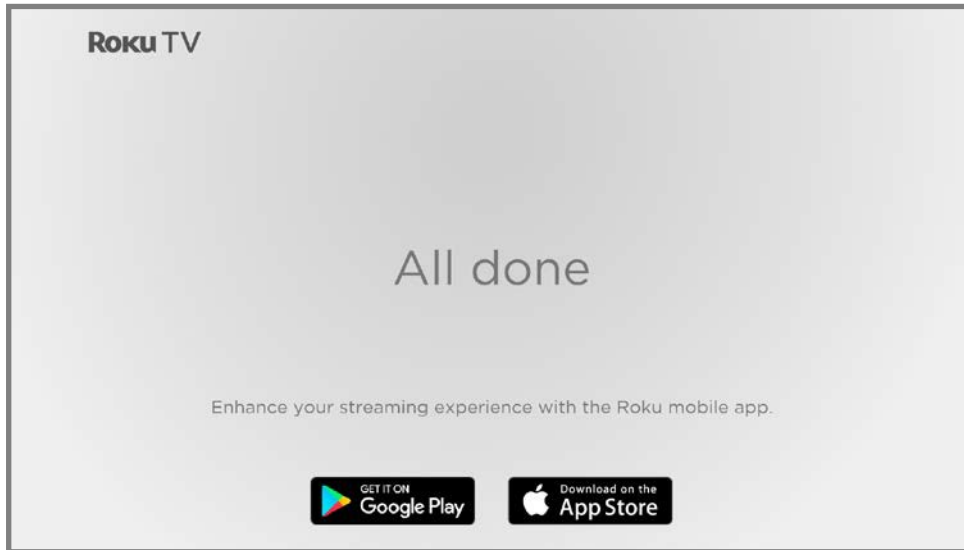
You're done with Guided Setup.



From here, you can explore everything your TV has to offer. Use the purple directional pad to move around, and then press **OK** to select a highlighted item. Press **HOME**  from whatever you are viewing to return to the Home screen.

We've designed the TV to encourage you to explore, and you can probably figure out most of the capabilities and settings on your own. If you have any questions or difficulties, you can find answers and solutions in this guide.

# The Home screen

The following illustrations shows a typical Home screen. The Home screen you see on your TV will vary depending on your location, theme, the number of TV inputs you've enabled, and the streaming channels and apps you've added.

**Note:** A paid subscription or other payments may be required for some channel content. Channel availability is subject to change and varies by country. Not all content is available in all countries or regions where Roku® products are sold.

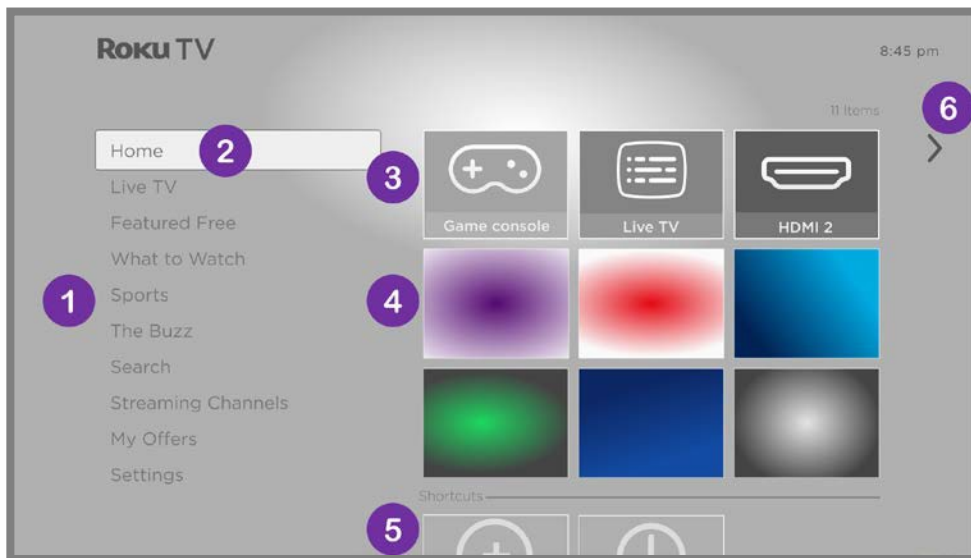

Typical Home screen

**Note:** The options appearing in the left navigation area vary by geographic location and might change from time to time.

1. Home Screen Menu - shows options available to you when you are on the Home screen. Actual options may vary depending on your Home screen settings and on periodic updates by Roku.
2. Highlighted option - press **OK** to select.
3. TV inputs - select an input to watch the connected device.
4. Streaming channels and apps - select an item and press **OK** to open it. You can add any number of channels from the [Roku Store](#).
5. Shortcuts - direct access to often used features.
6. Next screen hint - press **RIGHT** to see the next screen.



## Customize your Home screen

There are many things you can do to customize your Home screen and make it just right for you and your family:

- Add streaming channels by using the **Streaming Channels** menu option to browse the [Roku Store](#).
- [Change the screen theme](#) by going to **Settings > Themes** to find and pick one to suit your mood.
- [Customize the Home screen](#). Hide or show the shortcut items and options that appear in the Home Screen Menu.
- [Remove an item](#) by highlighting it and pressing **STAR \***. Then highlight **Remove input** or **Remove channel** and press **OK**.
- [Rearrange inputs and channels](#) by highlighting a tile and pressing **STAR \***. Then highlight **Move input** or **Move channel** and press **OK**. Use the purple directional pad to move the item, and then press **OK** to lock it in its new location. Move the shortcuts within the shortcut area only. Shortcuts are designed to always appear at the very bottom of the grid, so you can access them quickly by pressing **UP** once when you're at the top of the grid.
- [Rename a TV input](#) by highlighting it and pressing **STAR \***. Then highlight **Rename input** and press **OK**. Highlight a new name in the list, and then press **OK** to assign that name.

Rather than using the predefined names and icons, you can set a custom name and icon. To do so, scroll up or down to highlight **Set name & icon**, and then press **OK**. Follow the instructions on the screen to enter a name and select an icon for the input.

**Note:** If you specify a custom name for an input, voice commands might not reliably switch to that input. Voice commands typically can only switch among inputs that use built-in names, such as “AV,” and “Cable Box,” and “DVR.”

- Only on channels that you have subscribed through your linked Roku account, manage your subscriptions by highlighting a streaming channel and pressing **STAR \***. Then highlight **Manage subscription** and press **OK**. Select **Cancel subscription** and then follow the instructions to confirm your cancellation.

# Setting up live TV

In addition to the other entertainment possibilities of your Roku TV, you might want to watch broadcast channels from an antenna or cable TV provider connected to the **ANT/CABLE** input. On your Roku TV, you can watch broadcast TV in much the same way you watch other entertainment choices: select the **Live TV** input on the Home screen.

The first time you select the **Live TV** input, you have to set up the TV tuner. Setting up the TV tuner scans for active channels and adds them to your Live TV channel list.

---

## Why do I have to set up the TV tuner?

Not everyone needs to use the TV tuner. For example, you might have a set top box provided by a cable or satellite company that receives all of your channels. Most of these set top boxes use an HDMI® connection.

More and more people are watching only streaming TV and do not have a TV antenna or cable/satellite service. If you don't need the TV tuner, you can bypass setting it up and instead remove it from the Home screen as explained in [Remove unwanted inputs and channels](#).

When you set up live TV, the TV scans the signals on its antenna input for channels with a good signal, and adds those to the channel list, skipping dead channels and channels with a very weak signal.

The TV lets you add two analog channels, even if they have no signal, for the purpose of using an older set top box, VCR, or game console that can only output a signal on analog channel 3 or 4. Typically, you'll only need one of these channels, but both are provided to make setup simpler. You can hide the one you don't want as explained in [Edit live TV channel lineup](#).

---

## How do I set up the TV tuner?

1. Make sure your antenna or TV cable (not provided) is connected to the TV's **ANT/CABLE** input.
2. On the Home screen, select the **Live TV** input. If it is not on your Home screen, go to **Settings > TV Inputs** to add it.
3. Read the simple on-screen instructions, and then select **I have an antenna, search for channels**.

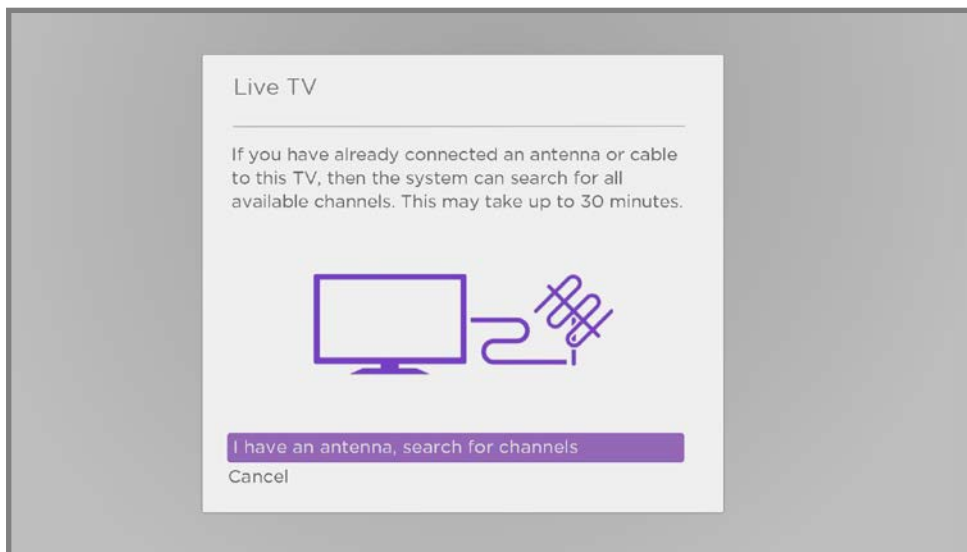

4. If prompted, select your time zone. You'll only need to do this if the TV can't figure out your time zone from your Internet connection.

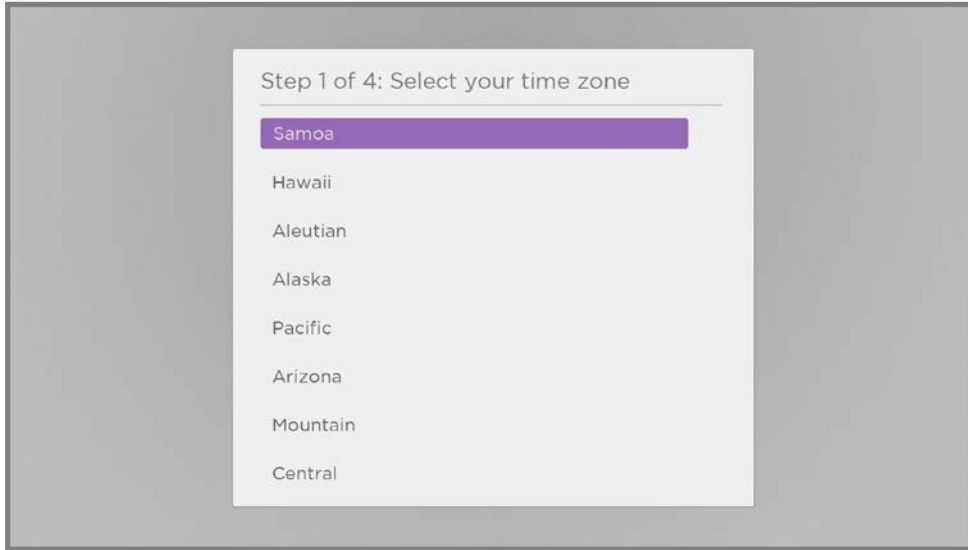

---

### Why does the TV need my time zone?

The TV needs to know your time zone so that it can correctly display time information about the program you are currently watching. In most cases, it can get the time zone automatically and skips this step.

---

5. When prompted, select whether to add analog channels 3 and 4. These channels enable you to connect older set top boxes, VCRs, or game consoles.



6. Wait while your TV scans for antenna channels ...

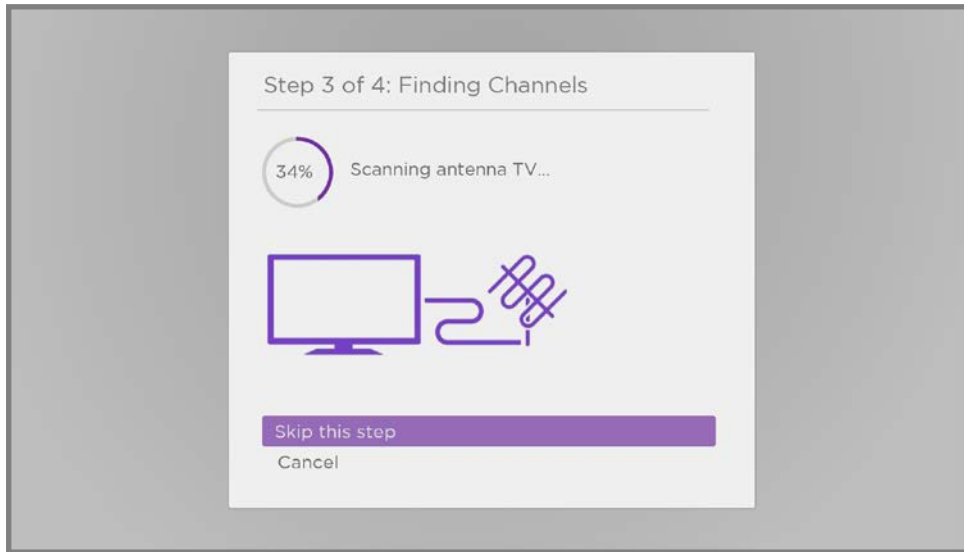

... and then cable TV channels.

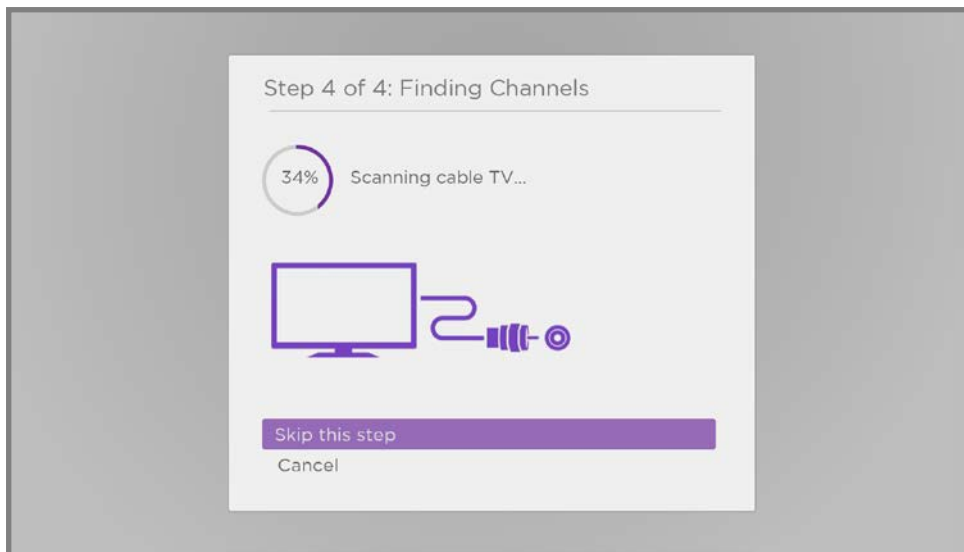

Scanning for channels can take several minutes.

**Tip:** If you don't have a cable TV provider, or if you use a set-top box to receive cable TV channels, you can save time by skipping the cable TV portion of the channel scan.

7. When the channel scans finish, the TV shows the number of channels it added.

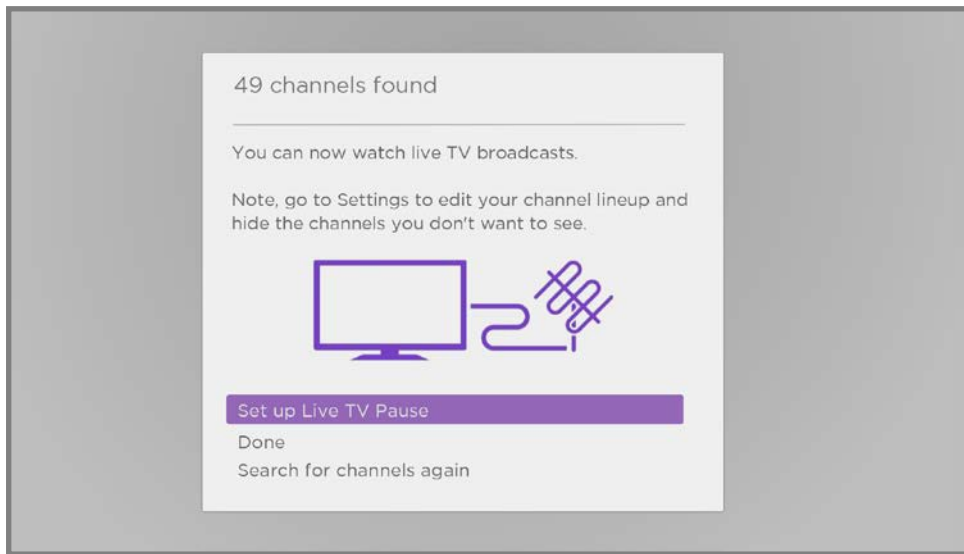

8. Only on certain models, you can set up Live TV Pause. The topic [Pausing live TV](#) explains how to set up and use this feature. If you don't want to set up Live TV Pause right now, or if this option is not available to you, select **Done** to start watching live TV.

**Tip:** Repeat the channel scan from time to time to make sure you are receiving all of the latest channels. Broadcasters and cable providers add and remove channels, move channels to different parts of the spectrum, and change the power levels of their channels periodically. Your reception and picture quality depend on the position of your antenna and on your location relative to the antennas of broadcasters in your area. To repeat the channel scan, use the purple directional pad to highlight the **Live TV** input, press **STAR \***, select **Scan for channels**, and then press **OK**.

You'll also have to repeat the channel scan if you remove and re-add the **Live TV** input on the Home screen or perform a factory reset.

Now, you're ready to watch live TV! While you're watching, try the following tips:

- Press **UP** or **DOWN** to change channels.
- Press **LEFT** to display the Live TV Channel Guide, and then press **UP** or **DOWN** to select a channel to watch. Or press **REWIND** ◀ or **FAST FWD** ▶ to jump through the Live TV Channel Guide a page at a time.
- Press **OK** to display information about the current program.
- Press **STAR \*** to see options for picture and sound settings.
- Use a Roku Voice remote, the Roku mobile app, Google Assistant, or Amazon Alexa to search for programs by title, actor, director, or genre. The TV or the Roku mobile app displays the results along with the streaming channels that offer the requested content.

**Note:** If your TV did not come with a Roku Voice remote, you can order one from <https://www.roku.com/products/accessories>.

# Using your TV

This section provides information on using the day-to-day features of your TV.

## Status indicator

Your TV has a single status indicator. It goes on and off and blinks in different ways depending on the status of the TV, as shown in the following table:

TV CONDITION	STATUS INDICATOR	MEANING
On (screen is active)	Off	Screen is communicating that TV is on.
Screensaver (screen is active)	Off	Screen is communicating that TV is on.
Off (no power)	Off	TV is not connected to power.
Off (standby)	On	TV is connected to power and is ready to use.
Starting up from off state	Slow pulsing blink until startup completes	TV is doing something.
On (receiving update from USB)	Slow pulsing blink until update completes	TV is doing something.
Remote command received	Dims on/off once	TV has received your command.
Network connection lost	Two short blinks, pause, repeat	TV was connected and paired with a Roku account and now has no network connection.
Powering down to standby mode	Slow pulsing blink until the TV reaches standby.	TV is doing something.

In standby mode, as long as the TV has power, the status indicator normally remains lit. If you prefer, you can turn the status indicator off when the TV is in standby mode. To change this setting, from the Home Screen Menu, navigate to **Settings > System > Power**, and then select **Standby LED**. Press **RIGHT** and then select **Off** or **On**, as desired.



## Standby mode energy savings

When you turn off your TV, it remains in a higher power mode for a few minutes, after which it goes into a very low power standby mode. If you turn on the TV again before it has entered the very low power mode, it turns on immediately. After the TV goes into the lower power standby mode, it takes a few seconds longer to start up.

You can optionally enable **Fast TV start**. When this option is enabled, your TV starts up almost immediately, but uses somewhat more power in standby mode. Fast TV start also gives you access to some additional features. For more information, see [Fast TV start](#).

## Opting in to Smart TV experience

The first time you select live TV, an HDMI input, or AV input, your TV offers to enable the Smart TV experience. If you decide to enable it at this time, you're all set to enjoy its recommendations and features.

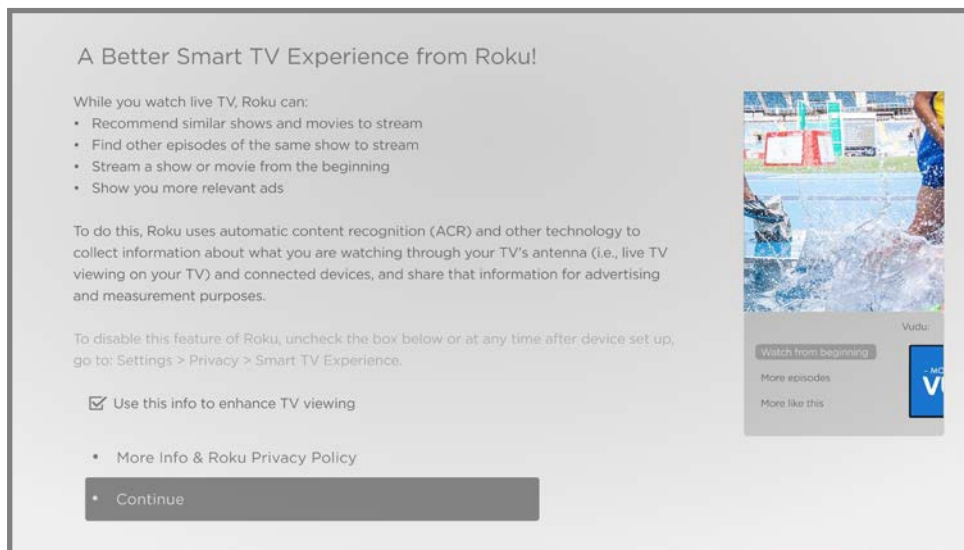

The Smart TV experience uses automatic content recognition (ACR) and other technology to collect information about what you watch on live TV, and on devices like media players and cable boxes connected to the **HDMI** or **AV** inputs. Opting in means that you give permission to analyze the programs you watch for the purpose of making recommendations, as well as showing ads that are more relevant to you.

If you decide not to enable the Smart TV experience at this first opportunity, you can enable it later. Or, if you decide you'd rather not use the feature, you can disable it, but be aware that previously collected information is retained and not deleted.

## Opting out of the Smart TV experience

If you decide you want to opt out Smart TV experience after you have opted in, follow these steps:

1. From the Home Screen Menu, go to **Settings > Privacy > Smart TV experience**.
2. Navigate to the right to highlight **Use info from TV inputs**.
3. Press **OK** on the remote to clear the check box.

## Disabling Auto Notifications

If you want to keep the Smart TV experience enabled, but you do not want to see notifications while you are watching programs, you can disable notifications. To do so, follow these steps:

1. From the Home Screen Menu, go to **Settings > Privacy > Smart TV experience**.
2. Navigate to the right to highlight **Use info from TV inputs**.
3. Press **DOWN** to highlight **Enable auto notifications**.
4. Press **OK** to clear the check box.

**Note:** These settings do not affect recommendations for More Ways to Watch that you see in the Live TV Channel Guide when watching live TV channels. Those recommendations show up only in the Live TV Channel Guide and do not rely on ACR technology.

## Watching live TV channels

Select the **Live TV** input on the Home screen. Your TV remembers the last channel you watched and starts with that channel playing.

### Changing channels

To change channels, you can do any of the following:

- Press **UP** to change to the next higher channel.
- Press **DOWN** to change to the next lower channel.
- Press **LEFT** to display the Live TV Channel Guide, and then press the arrow keys to select the channel or program you want to watch. Press **REWIND** ◀◀ or **FAST FWD** ▶▶ to move through the list one page at a time. When you've highlighted the channel or program you want to watch, press **OK**. (If you decide you don't want to change channels, press **BACK** ←.)
- Only if Live TV Pause is not enabled, press **REPLAY** ↺ to jump to the previous channel. Press again to return to the channel you were watching before you pressed **REPLAY** ↺.

## Using the Live TV Channel Guide

Use the Live TV Channel Guide to find both over-the-air and live streaming TV programs. The Live TV Channel Guide lets you scroll through all the TV channels you receive (except those you have hidden, if any), plus a large number of live streaming programs. You can see what's on right now and the upcoming 14 days.

For live, over-the-air TV programs, you can use More Ways to Watch to find the program you're watching and start watching it from the beginning from one of your streaming channels. Your clue that there are More Ways to Watch a program is a purple star (\*) next to the program name in the guide.

For example, you might turn on your TV at 10 minutes past the hour and discover you are missing the current episode of the program you wanted to watch. But there is a purple star next to the program title, so you can press **STAR \*** and learn that there are several streaming channels where you can watch the current episode from the

beginning. You also can find more episodes of your program, and other programs that have a similar theme.

**Note:** A paid subscription or other payments may be required for some streaming channels.

To open the Live TV Channel Guide, press **LEFT** while watching live TV. It opens with the name of the current program highlighted, and a lot more information.

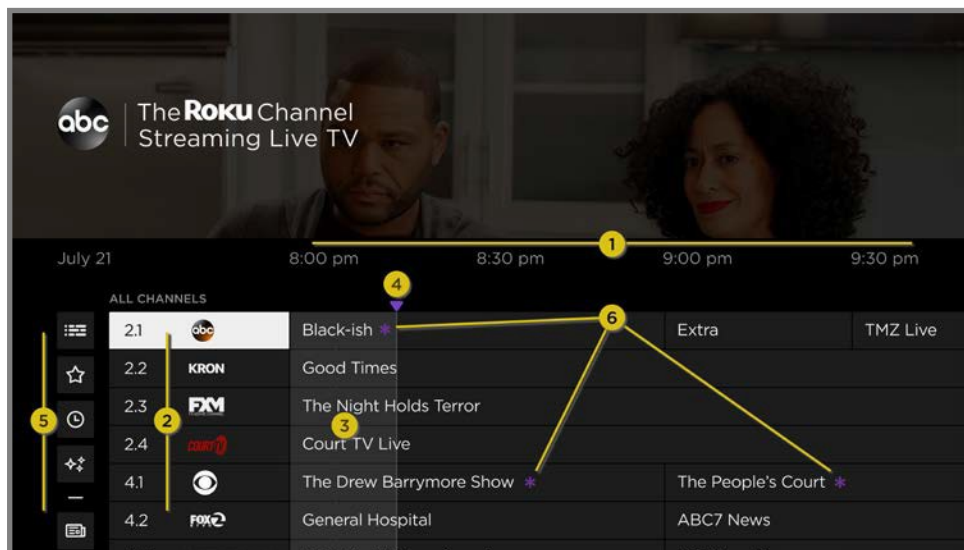

1. Time slots. Navigate **LEFT** or **RIGHT**. Press **FAST FWD** **▶▶** or **REWIND** **◀◀** to skip ahead or back a screen at a time.
2. Channel list. Navigate **UP** or **DOWN**. Live TV Categories is currently set to All Channels.
3. Program list. Shaded area is prior to the current time.
4. Progress bar. Indicates the current time relative to the listed programs.
5. Live TV Categories list, currently set to ALL CHANNELS. Navigate to this list, and then navigate up and down to select a category. See [Using Live TV Categories](#) for more information.
6. More Ways to Watch indicator. See [More Ways to Watch](#) for more information.

When you are viewing the current time slot, notice that the Live TV Channel Guide shows a lighter background for portions of programs before the current time, and a darker background for programs and portions of programs that have not yet aired. The line dividing these two zones is the progress bar.

## Navigating the Live TV Channel Guide

- Use the purple directional pad to move up, down, left, and right.

- To switch to a program that is currently in progress, highlight it, and then press **OK**. (Note that pressing **OK** on a past or future program does nothing.)
- To return to the current time after navigating to a different time slot, press **REPLAY** ↺.
- To return to the currently airing program without causing a channel change, press **BACK** ←.
- To see [More Ways to Watch](#), highlight any program that has a purple asterisk (\*), and then press **STAR \***. While using the Live TV Channel Guide, navigate all left to highlight a channel number, and then press **STAR \*** to open the **Channel options** dialog.

## Using Live TV Categories

The list of channels you receive can become quite long, especially when it includes both over-the-air channels and live streaming channels. Use Live TV Categories to show only the channels that interest you at the moment.

With the Live TV Channel Guide open, navigate left past the channel list to expand Live TV Categories. From the list of categories, navigate up or down to select **All Channels**, **Recents**, or **Favorites**. If you have not hidden live streaming channels, the list of categories also includes a list of curated channels, such as **Recommended**, **News**, **Sports**, **Kids & Family**, **Music**, **Game Shows**, and more.

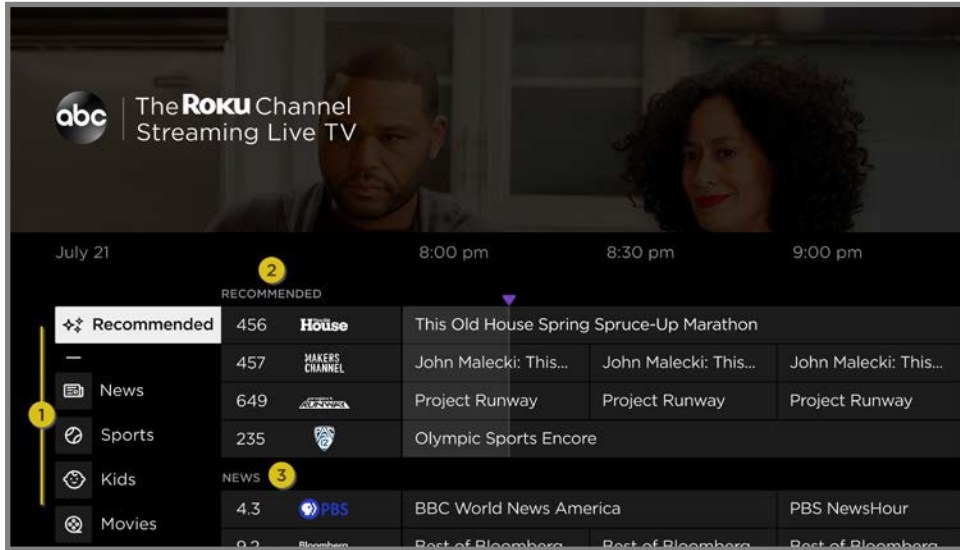

1. Live TV Category list. Navigate up or down to highlight a category.
2. Selected category appears at the top of the channel list.
3. Other categories remain available if you navigate beyond the channels in the selected category.

With a category highlighted, navigate right into the channel list. The guide shows channels belonging to the selected category. Note that you can also see channels in other categories by navigating up or down without changing your category selection.

The category you select is temporary—the next time you view the Live TV Channel Guide, it again shows **All Channels**.

## Changing channel options

While using the Live TV Channel Guide, navigate left to the channel number column, and then press **STAR \*** to open **Channel options**.

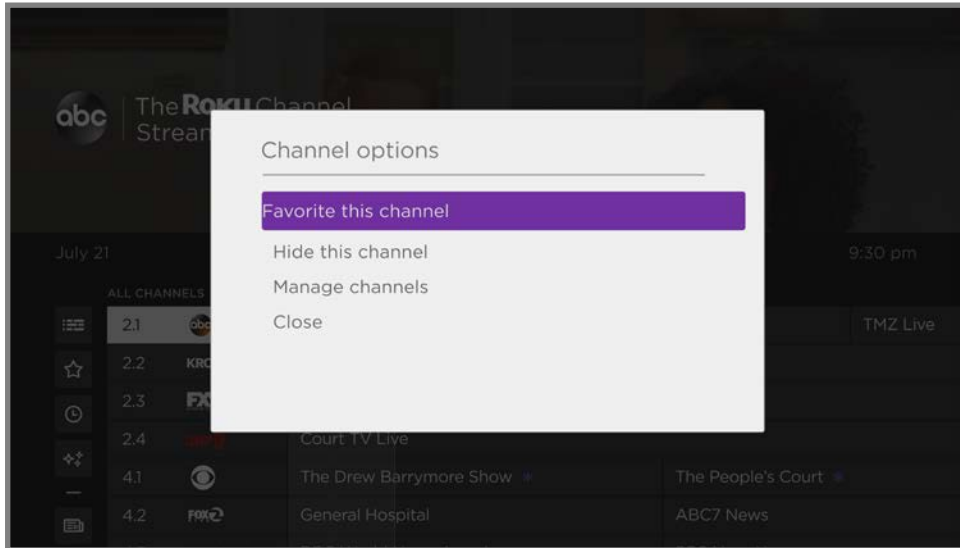

**Favorite/Unfavorite this channel** – Select this option to make the selected channel a favorite. Select again to remove the channel from your favorites.

**Hide/Unhide this channel** – Select this option to hide the current channel. Select again before moving on to unhide the channel if you hid it by mistake. But note that after you close the dialog, you cannot access the channel to unhide it. Instead, use the **Manage channels** option to unhide hidden channels.

**Manage channels** – Opens the **Manage Channels** menu where you can edit the channel lineup and mark certain channels as favorites. See [Manage channels](#).

## Viewing program information

When you are viewing a program and no other guides or menus are open, press **OK** to view program information in a banner at the bottom of the screen.

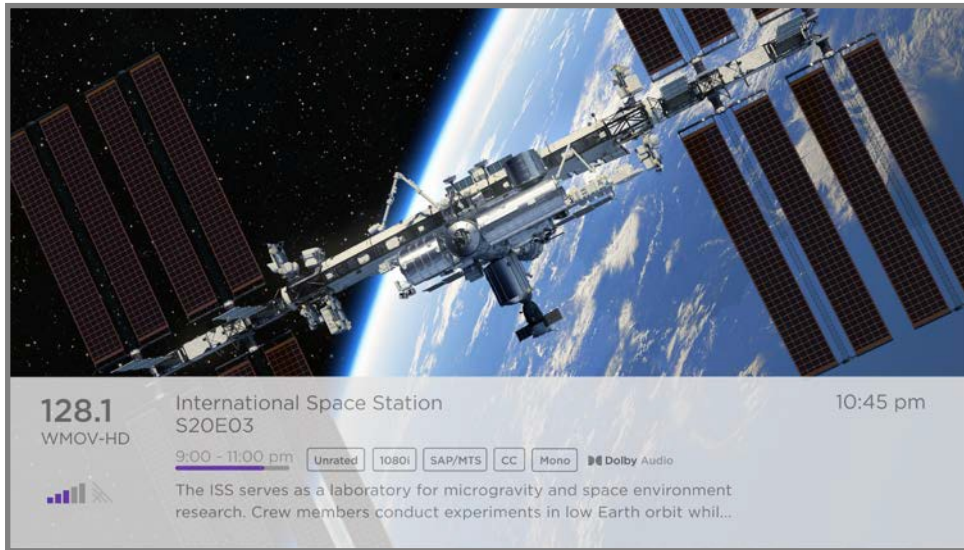

Program information banner

This banner provides details about the program you are watching. These details vary depending on the information available and the source of the show (over-the-air or live streaming)

**Tip:** If you've enabled Live TV Pause and you're watching live TV, you'll also see a progress bar showing the current playback position within the rolling 90-minute pause time. For more information, see [Pausing live TV](#).

## Adjusting settings while watching a program

Press **STAR \*** to display the **TV settings** menu. Press **UP** or **DOWN** to highlight an option, and then press **LEFT** or **RIGHT** to change the setting. The topic [Adjusting TV settings](#) explains each of the settings in detail.



# Pausing live TV

Only on certain models, Live TV Pause gives your Roku TV the ability to pause, play, fast forward, and rewind digital live TV received on the **ANT** input. You can pause live TV for up to 90 minutes.

## Requirements

To use this feature, you need to:

1. Connect your TV to a Roku account. If you didn't connect during Guided Setup, see [Connecting your TV](#).
2. Provide your own USB flash drive (thumb drive) with the following minimum specifications.
  - 16 GB
  - 15 Mbps read/write speed
  - USB 2.0 compliant

A USB flash drive (thumb drive) meeting the minimum requirements is highly recommended over an externally powered hard disk drive. Note that you can use any larger size drive—there is no limit to the maximum size—but using a larger drive does not extend the 90-minute pause time.

**Important:** After warning you and giving you a chance to cancel Live TV Pause setup, all existing content on your USB drive is erased when you enable this feature.

3. Connect your USB drive to the TV's USB port.

**Important:** Some TV models have more than one USB port. You can connect your Live TV Pause USB drive to any port, but make sure that nothing is connected to other USB ports while enabling Live TV Pause. Reconnect other USB devices after you have finished enabling Live TV Pause.

4. Enable Live TV Pause, as explained in the following topic.

## Enabling Live TV Pause

You can start setting up Live TV Pause in any of the following ways:

- After completing a channel scan, select **Set up Live TV Pause** from the available options.
- Press **PLAY/PAUSE ▶||** on the Roku remote while watching a live TV channel.
- Highlight the **Live TV** input on the Home screen, press **STAR \*** on the remote, and then select **Enable Live TV Pause**.

After starting setup of Live TV Pause in any of these ways, the TV prompts you through the steps needed to enable this feature. Setup takes only a few moments.

**Note:** Use of a USB hub is not supported.

## Using Live TV Pause

If you have used the Roku remote to watch streaming channels, using Live TV Pause should be very familiar to you.

- While watching a digital live TV channel, press **PLAY/PAUSE ▶||** to pause or play the content. After the TV program has been paused for 90 minutes, the TV resumes playing from the point in the program where you paused it.
- After watching a channel for a while, press **REWIND ◀◀** to jump back up to the point where you first started watching the channel, up to 90 minutes.
- After pausing or rewinding, press **FAST FWD ▶▶** to jump ahead up to the point where you are once again watching the live TV program.
- Press **FAST FWD ▶▶** or **REWIND ◀◀** repeatedly to cycle through 1x, 2x, and 3x skip speeds. Press **REPLAY ↺** to play back the last several seconds of the program.
- When the program is paused, press **LEFT** or **RIGHT** to move backward or forward through the program approximately 10 seconds per press. Small frames appear across the screen to identify your location in the program.

Whenever you use any of the Live TV Pause features, the TV momentarily displays a progress bar:

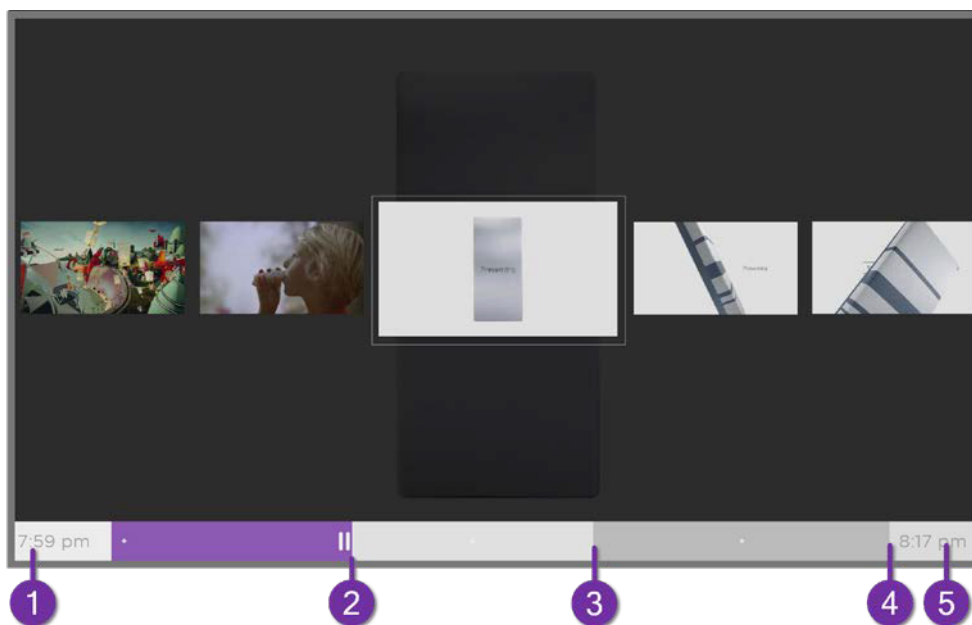

1. Time at the current playback position.
2. Current playback position
3. Extent of pause time, representing the amount of time this channel has been buffered, up to 90 minutes.
4. 90-minute mark, representing the maximum extent of pause time.
5. Current time.

The progress bar also shows tick marks at each half hour point, to help you locate the boundaries where one program ends and a new one begins.

## Notes about Live TV Pause

- You can use Live TV Pause only with digital broadcast and cable channels received through the TV's **ANT** input (ATSC and Clear QAM channels).
- Changing channels erases and restarts the Live TV Pause buffer.
- Returning to the Home screen, selecting another input, or turning off the TV erases and resets the Live TV Pause buffer.
- Disconnecting the USB drive erases the Live TV Pause buffer.

## More Ways to Watch

More Ways to Watch gives you recommendations about the programs you're watching on the **ANT**, **HDMI**, and **AV** inputs. You will automatically get these recommendations in the Live TV Channel Guide for live TV programs. However, before you can get recommendations for programs you're watching through the **HDMI** or **AV** inputs, you must opt in to the Smart TV experience to acknowledge that you want to allow the TV to use automatic content recognition (ACR). See [Opting in to Smart TV experience](#) for details.

### Using More Ways to Watch

Not every program provides recommendations. As you use More Ways to Watch, be aware that you'll only see suggestions on your TV when all of the following conditions are met:

- Your TV is in the United States.
- You have enabled **Smart TV experience** if you are watching programs through an **HDMI** or **AV** input. (If you are watching live TV from the **ANT** input, this setting does not matter.)
- The program you're watching contains the information needed to identify it. Note that some programs, such as the daily news, typically do not activate More Ways to Watch.
- At least one participating streaming channel offers the movie or TV program you are watching, or other episodes, or more programs like the one you are watching.

If all of these conditions are met, you can view the suggestions. More Ways to Watch recommendations appear in two different places:

- When watching the **HDMI** and **AV** inputs, you'll see a **More Ways to Watch** notification in the lower right corner of the screen for a few seconds unless you have disabled **Enable auto notifications**. Press **STAR \*** to see the list of matching programs.

**Note:** After this banner disappears, you can restore the *More Ways to Watch* prompt by pressing **OK**.

- In the Live TV Channel Guide, all programs that meet the criteria for More Ways to Watch display a purple asterisk \* next to their titles:

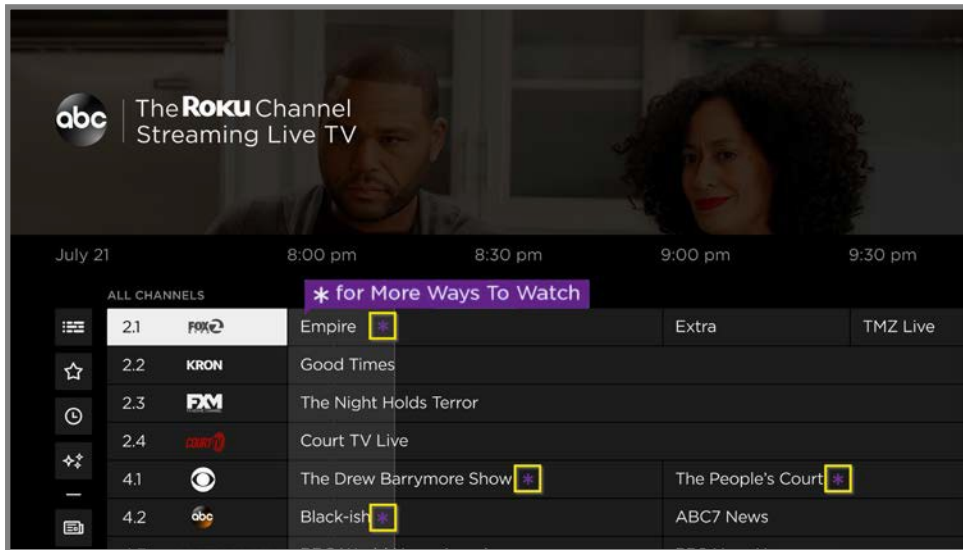

Highlight the program of interest and press **STAR \*** to see recommendations.

Regardless of how you got to this point, the options you'll see depend on the type of program you're watching and the available ways there are to watch, so you might see any or all of the following:

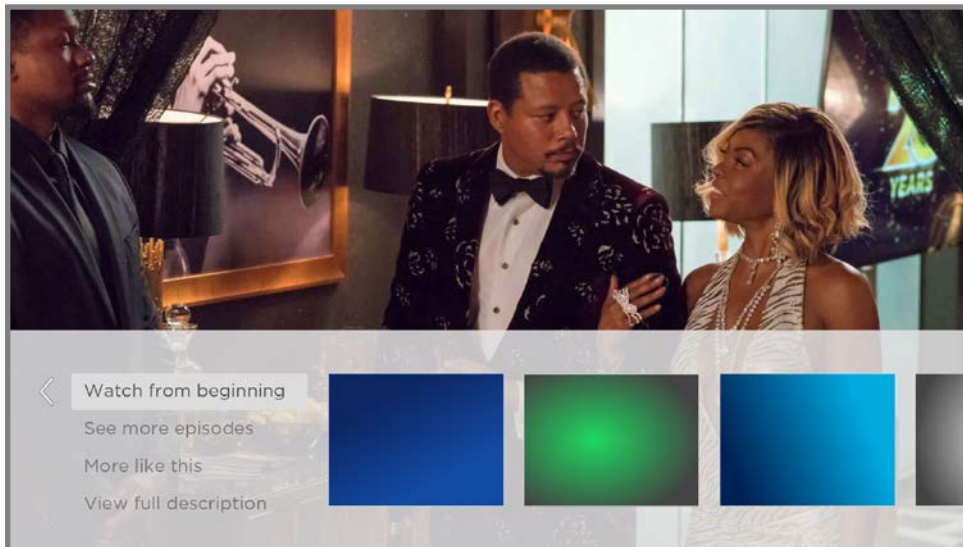

- **Watch from beginning** – Streaming channels on which the same TV program or movie is available. Often, this option does not appear on first

run programs, because streaming content typically is not available until sometime after the program is first broadcast.

- **See more episodes** – Streaming channels where you can find other episodes of the TV program you are watching. Does not apply to movies.
- **More like this** –TV programs or movies with a similar theme.
- **View full description** – Full description of the selected program.

Press **DOWN** to select an option, and then press **RIGHT** to select the streaming channel you want to watch.

Assuming you've already added the channel and completed any required sign-in, More Ways to Watch takes you directly to the program in the streaming channel where you can select and watch the program. Otherwise, it prompts you to add the channel and, if you do, then takes you to the program.

## Getting the most from More Ways to Watch

- Streaming channels you've already installed appear first in the list of suggestions.
- When you select a streaming channel, you leave the program you are currently watching.
- If you've used the Live TV Pause feature to pause the program, your paused program buffer is deleted. In other words, you cannot return to a live TV channel and resume watching from where you left off.

## Switching TV inputs

Switch TV inputs to access the device connected to that input, for example, a Blu-ray™ player. To switch inputs, highlight the input on the Home screen, and then press **OK**. The video signal on the input plays on the screen.

**Tip:** To learn how to add, remove, rename, and rearrange the inputs and channels on your Home screen, see [Customizing your TV](#).

## Auto-detecting devices

Your TV automatically detects when you connect a new device to an **HDMI**® input and turn on its power. The input is automatically added to the Home screen if it isn't already present.

## Auto-naming devices

When you connect and power on an HDMI device, your TV identifies it, automatically renames the input, and changes its icon to suit the device. For more information, see [Rename inputs](#).

## Adjusting audio/video settings

While watching video content on any input, press **STAR \*** to display the **TV settings** menu. Press **UP** or **DOWN** to highlight an option, and then press **LEFT** or **RIGHT** to change the setting. To learn about each of the audio and video settings, see [Adjusting TV settings](#).

## Setting preferred audio language for streaming channels

You can select the preferred language for the audio played by streaming channels. If the selected language is available in the streaming content, the TV plays that language.

To set the preferred audio language:

1. From the Home Screen Menu, navigate to **Settings > Audio > Audio preferred language**.
2. Press **RIGHT** to highlight one of the languages.
3. Press **UP** or **DOWN** to highlight the language you want to use.
4. Press **OK**.

**Note:** Many streaming channels have an option to select the language while you are watching a program. The *Audio preferred language* setting sets the default for that option.

## Automatic game console configuration

Your TV automatically detects select game consoles and configures the key features it supports to optimize TV performance while playing video games. When you connect a supported and powered-on game console through an HDMI® input, the TV automatically changes the input icon to the game console's icon<sup>1</sup>. Only on certain models with compatible game consoles, it also enables any of the following features, if available:

- Automatic low-latency mode (ALLM)
- Variable refresh rate
- HDR gaming
- High frame rate
- Game mode
- THX Certified game mode

Various combinations of these features are available only on certain models, and if present, can be disabled by navigating to **Settings > TV inputs** and then selecting the appropriate HDMI input.

When you start playing a game, your TV displays a message at the bottom of the screen to make you aware of the settings that it will use.



<sup>1</sup> Certain game consoles, such as the Microsoft Xbox One, do not communicate their identity until you select the input after connecting the console.



Select **Cancel** before the timer runs out to keep the current TV picture settings. For example, you might want to cancel automatic game configuration if you are watching a movie from your game console.

## Using Roku Voice commands

Roku Voice commands<sup>1</sup> make it fast and easy to control your TV and find entertainment with simple voice commands like “show me comedies.” Control your TV with commands like “switch to game console,” or “watch channel 7.1.” Use your Roku Voice remote, the Roku mobile app, or a compatible smart speaker to speak commands. When using a smart speaker, add “on my Roku” or, for example, “on my bedroom Roku” to the end of the command.

To learn what commands to use, watch out for hints that appear at appropriate times. For example, if you are in the **TV settings** menu with the **Sleep timer** command highlighted, a hint might appear explaining how to use a Roku Voice command to set the sleep timer. You can use Roku Voice commands at any time, without first calling up a menu.

Tap **Voice**  on your remote to see helpful hints about how to use Roku Voice, and then explore these additional voice features:

- See what’s on TV in the Live TV Channel Guide. Say “Show Guide.”
- Jump to a specific channel. Say “Go to 7 point 3” to open Live TV on channel 7.3. Or say, “ABC News” (or another program name that has multiple options). Because there are multiple sources of ABC News, you’ll see a panel where you can choose the one you want.
- Use voice commands to launch streaming channels, switch inputs, or change live TV channels. Say, “Go to Netflix” to open Netflix. Or say, “Show This Old House” to go to that live program on The Roku Channel.
- Set sleep timers. For example, say “Turn the TV off in 30 minutes”, or “Go to sleep at 11 p.m.”

---

<sup>1</sup> Roku Voice supports English, French, Spanish, Portuguese, and German languages when the corresponding TV language is selected.

- Go directly to playing a program whenever your search command can be uniquely identified and the requested content is available at no additional cost to you.<sup>1</sup>
- Search for movies based on popular quotes. For example, say “What movie is this from – ‘Here’s looking at you, kid’.”
- Only on 4K TVs, say “Show me 4K movies” to see a list of 4K movies available across participating streaming channels.
- Use Roku Voice to make entries in a variety of on-screen keyboards. Keyboards that support voice entry have a microphone icon next to the input field. You can say letters, characters, and numbers for an easy way to enter the required information. The TV displays helpful hints at appropriate times to provide guidance.
- Use voice commands to turn the display off (for enjoying streaming music), turn closed captions on or off, and to replay the last few seconds of a movie or TV program.
- Control Roku Media Player to play your personal music and show movies and photos. Say commands like, “Play classic rock on Roku Media Player,” “Skip ahead 20 seconds,” or “Play the next song.”
- Get help by pressing **VOICE**  and saying, “Help.”

---

<sup>1</sup> Direct-to-playback commands spoken in English or Spanish work with selected streaming channels. Direct playback occurs only when there is a high confidence of match, the content is free or you are already subscribed, and the channel is already added to your Home screen.

## Using Roku Voice with Apple Siri

Ask Siri on your Apple device to control your Roku TV with just your voice<sup>1</sup>. Say things like “Hey Siri, play jazz on the living room TV” to play music from your iPhone, iPad, Apple Watch, HomePod Mini, or Mac on your Roku TV.

Roku TVs also support Apple HomeKit<sup>1</sup>, which allows you to easily and securely control your Roku device while using the Home app or Siri. After installing your Roku TV, set it up with just a few simple steps within the Apple Home app. You can even create your own custom automations and scenes that include HomeKit-enabled accessories such as your Roku TV, to control your home setting. For more information, see [Apple Home app](#). For details about what Apple HomeKit controls are available with your TV, see the Roku support article, [How to use AirPlay and HomeKit with your Roku streaming device](#).

## Using Roku Voice with Google Home

Use Google Home, Google Pixel phone, or the Google Home mobile app to control your Roku TV. You can search for movies and TV programs, launch most channels, control playback, adjust the volume, switch inputs, turn the TV on and off, and more. Control multiple Roku devices by including the location of the device in your commands. For example, say “Hey Google, turn off Roku in the bedroom.” For information on linking and controlling your TV with Roku Action on Google, see the Roku support article, [How to use Google to control your Roku streaming device](#).

## Using Roku Voice with Amazon Alexa

Use Amazon Echo Dot, Echo Plus, Echo Show, or the Amazon Alexa mobile app to control your Roku TV. You can search for movies and TV programs, launch most channels, control playback, adjust the volume, switch inputs, turn the TV on and off, and more. Control multiple Roku devices by including the location of the device in your commands. For example, say “Hey Alexa, pause Roku in the living room.” For information on adding the Alexa Roku skills and controlling your Roku TV, see the Roku support article, [How to use Amazon Alexa to control your Roku streaming device](#).

---

<sup>1</sup> Apple AirPlay 2 and HomeKit are supported by all Roku TVs except for Hardware IDs beginning with “6” (6XXXX) and “5” (5XXXX).

# Using Roku Voice Remotes (certain models only)

Only on TVs with the Roku Voice remotes: The following topics explain how to get the most out of your TV when it includes a Roku Voice Remote, Roku Enhanced Voice Remote, or Roku Voice Remote Pro.

## Connecting headphones to a Roku Voice Remote



Certain TVs come with the Roku Enhanced Voice Remote or Roku Voice Remote Pro. On these models, you can connect headphones to the jack on the left side of the remote.

**Tip:** Inserting a plug in the remote's headphone jack disables the sound from the TV's built-in speakers or attached receiver or soundbar. The volume and mute controls on the right side of the remote adjust the volume level of the connected headphones. You might notice that connecting headphones to your remote shortens the remote's battery life somewhat.

**Warning:** Loud noise can damage your hearing. When using headphones, use the lowest volume setting on your headphones that still lets you hear the sound.

## Re-pairing your Roku Voice Remote

Roku Voice remotes operate with wireless radio signals and must be paired with your TV. You initially paired the remote when you set up your TV during Guided Setup. But if your remote loses its pairing with the TV for some reason, you can easily re-pair it using either of the following methods:

1. If your remote uses replaceable batteries, remove the battery cover from the back of the remote.
2. Depending on your remote model, either:
  - Press and hold down the pairing button for 3 seconds or longer, until the adjacent LED flashes.
  - Hold down **HOME**  and **BACK**  at the same time for 5 seconds, until the adjacent LED flashes

3. Do one of the following:

- Turn on the TV using the power button on the TV side or back panel. Pairing occurs as the TV starts up.
- Use the Roku mobile app or a different remote to navigate to **Settings > Remotes & devices > Pair new device > Remote**.

**Tip:** If the remote fails to pair with the TV, try installing new batteries or charging the remote, as applicable. Also, it's helpful to hold the remote within two to three feet of the TV to ensure successful pairing.

## Checking the Roku Voice Remote battery level

You can check the condition of the batteries in your Roku Voice remote at any time by navigating to **Settings > Remotes & devices**, and then pressing **OK** to select your remote below **My paired devices**. With your remote selected, navigate right to **About > Remote** to view its **Battery level**. The resulting screen displays not only the battery level, but also other information that can be useful when you need technical support with your remote.

**Tip:** When you first turn on the TV, a battery level indicator appears in the upper right corner of the screen for a few seconds.

## Finding your Roku Enhanced Voice Remote or Roku Voice Remote Pro

Only on TVs with the Roku Enhanced Voice Remote or Voice Remote Pro, when your remote has found its way down into the sofa cushions or your dog has hidden it in the corner, you can use the Find Remote feature to find out where it's hiding. This feature has a limited range, and is designed to find your remote somewhere in the same room as the TV.

There are multiple ways to activate the lost remote finder:

- **Activate lost remote finder with hands-free voice command**

Only if you have a Voice Remote Pro, say "Hey Roku, where's my remote?"

Note that this command only works if you have hands-free voice turned on.

- **Activate lost remote finder from the Settings menu**

Only if you have another working remote, navigate to **Settings > Remotes & devices > Remotes**. Then highlight your remote in the list, and select **Find remote**.

- **Activate lost remote finder with the Roku mobile app**

After you install the free Roku mobile app, you can open it and trigger the lost remote finder in either of the following ways:

- On your **phone**: Select the **Devices** icon  from the navigation bar and make sure you are connected to your Roku TV. Next, tap the three dots to the right of your TV name and select **Ping Remote**.
- On your **Roku** device: Select the Remote icon from the navigation bar in the Roku mobile app. Using the mobile app as your remote, navigate to **Settings > Remotes & devices > Remotes**. Then highlight your remote in the list, and select **Find remote**.

- **Activate lost remote finder with panel buttons**

**Note:** The panel button(s) on some models might be difficult to find. If the location is not obvious, check the bottom center of the TV behind the status indicator LED, or the back panel of the TV near the lower right or left side.

- On TVs that have a single button control, short press the button to open the **Inputs** menu, and then short press it again to select **Find Remote**. In a few moments, the TV accepts your selection and triggers the lost remote finder.
- On TVs that have a three button control, short press the middle button to open the **Inputs** menu, and then short press it again to select **Find Remote** to trigger the lost remote finder.
- On TVs that have a joystick-style control, press to the **Left** or **Right** to open the **Inputs** menu, and then press **Right** to scroll down to **Find Remote**. In a few moments, the TV accepts your selection and triggers the lost remote finder.

- On TVs that have a column of labeled panel buttons, press the **INPUT** button to open the **Inputs** menu, and then press the **INPUT** button again until you highlight **Find Remote**.

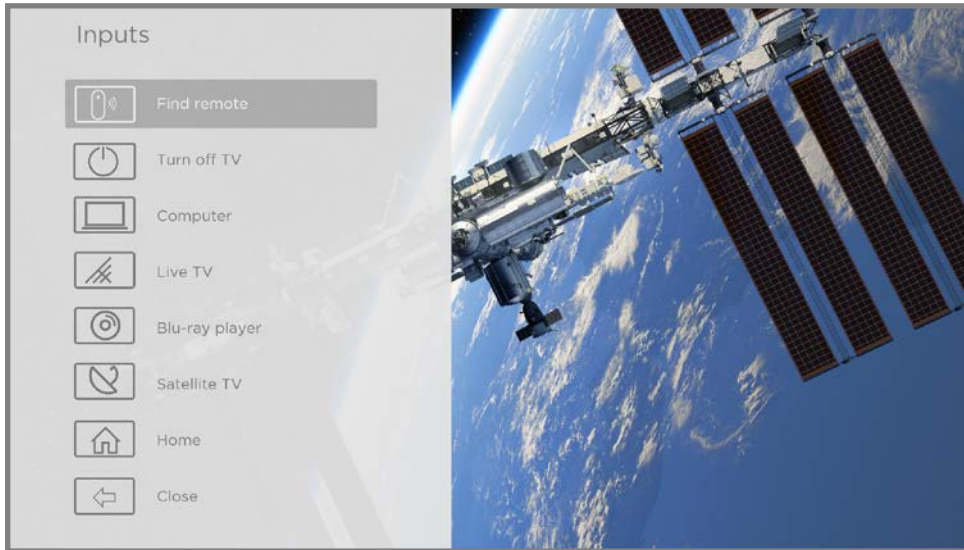

### Inputs menu

A moment or two after highlighting **Find Remote**, the remote starts playing your selected remote finder sound to let you know where it is hiding. The sound automatically stops after a minute or after you find the remote and press any button.

## Changing and previewing the remote finder sound

Only on TVs with the Roku Enhanced Voice Remote or Voice Remote Pro, you can customize the sound your remote makes when you use the Find Remote feature. To customize the sound, navigate to **Settings > Remotes & devices > Remote settings > Change remote finder sound**. Select the sound you want to use from the available settings.

To preview the sound you have chosen, select **Preview remote finder sound**, and then hold down **OK** on the remote to play the sound. When you release the **OK** button, the sound will stop.

# Playing content from USB storage devices

Use Roku Media Player to play personal music, videos, and photo files from a personal USB flash drive or hard disk connected to the TV's USB port.

To use this feature, make sure your media files are compatible with Roku Media Player. To see the latest list of supported formats, view **Help** in the Media Player<sup>1</sup>. Roku Media Player displays only supported file types, and hides file types it knows it cannot play.

**Note:** If you do not see Roku Media Player on your Home screen, it might have been uninstalled. You can reinstall it from the Roku Store.

For more information about playing back your personal videos, music, and photos, go to the following link on the Roku web site:

[go.roku.com/rokumediaplayer](http://go.roku.com/rokumediaplayer)

## Auto player launch

You can set your TV to automatically open Roku Media Player when you connect a USB drive with a recognizable file system (such as FAT16/32, NTFS, HFS+ or EXT2/3). To configure this setting, from the Home Screen Menu, navigate to **Settings > System > USB media**. Choose from the following options:

- **Auto-launch** – Select **Prompt**, **On**, or **Off**, as desired.
  - **Prompt** – (default) Display a prompt each time a recognized USB drive is connected. The prompt provides options to launch Roku Media Player as well as to change future auto-play behavior.
  - **On** – Always launch Roku Media Player whenever you connect a recognized USB drive.
  - **Off** – Never launch Roku Media Player automatically.
- **Launch channel** – Select the app you want to use to play back media files.

---

<sup>1</sup> There are many variants of each supported media format. Some variants may not play at all or may have issues or inconsistencies during playback.



## Playing content from local network media servers

Roku Media Player can play personal video, music, and photo files from a media server on your local network. Media servers include personal computers running media server software such as Plex or Windows Media Player, network file storage systems that have built-in media server software, and other devices that implement the specifications of the Digital Living Network Alliance. Some servers do not fully implement the DLNA specification but are UPNP (Universal Plug and Play) compatible. Roku Media Player can connect to them as well.

Some media servers can convert files into Roku compatible formats. Digital Rights Management (DRM) protected content is not supported.

## Setting up a payment method

For channels that allow you to pay through your linked Roku account, you can enter a payment method directly on your TV. Entering a payment method on your TV means that you don't need to go to a computer or mobile device to set up a payment method.

To add a payment method:

1. From the Home Screen Menu, navigate to **Settings > Payment method > Add payment method**.
2. Follow the prompts to update your payment method by selecting one of the listed options.

**Note:** If you have already set up a payment method on my.roku.com, that payment method is identified here in such a way as not to expose any personal data. You can use this screen to change your payment method, if desired.

3. Select **Save card**, and then press **OK**.

To manage your saved payment method and to see other payment methods, log into your account at [go.roku.com/pay](https://go.roku.com/pay).

## Using your TV in a hotel or dorm room

Hotels, school dorms, conference facilities, and similar locations with public wireless Internet access often require you to interact with a web page to authenticate your access. These types of networks are called restricted public networks. When you select a network of this type, the TV automatically detects that additional information is needed and prompts you through using another wireless device to supply the requested information.

### About using your TV on a restricted public network

Here are some points to keep in mind when using your TV on a restricted public network:

- Using your Roku TV on a hotel or dorm room network requires wireless availability and a network-connected smartphone, tablet, or computer to authenticate access to your wireless access point.
- You will need your Roku TV remote.
- Some content might be limited or unavailable if you try to connect outside your home country due to geo-filtering.

### Connecting your Roku TV on a restricted public network

1. When setting up a network connection (either during Guided Setup or using **Settings > Network > Set up connection**), the TV automatically detects that you are connecting to a restricted network and displays the following prompt:

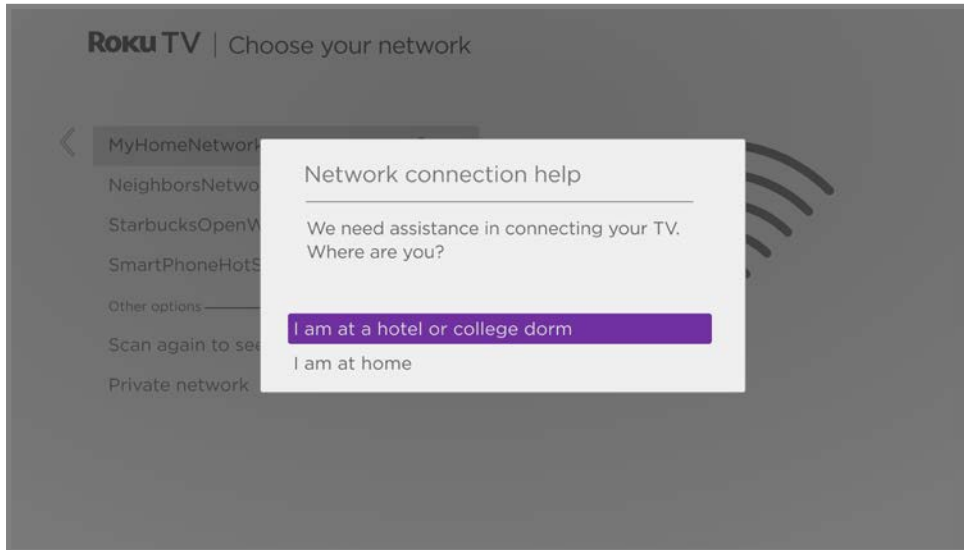

**Tip:** Your TV can connect to a restricted network only if *Enable 'Device connect'* is selected in **Settings > System > Advanced system settings**. *Device connect* is enabled by default, but if you have disabled it, the TV cannot complete the connection.

2. After selecting the correct network, highlight **I am at a hotel or college dorm**, and then press **OK**. The TV prompts you to use your smartphone, tablet, or laptop to complete the connection.

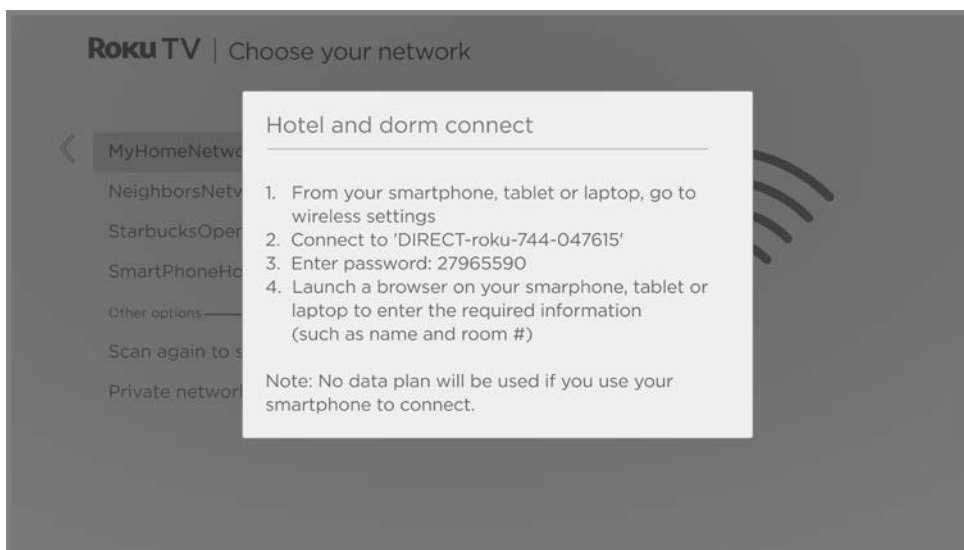

3. Use a mobile phone, tablet, or wireless-enabled computer to detect wireless networks. In most cases, you can simply open the device's Wi-Fi Settings or Network Settings screen to start scanning.

**Note:** The mobile phone, tablet, or computer must be on the same wireless network to which you are connecting the TV.

4. Connect to the network named on your TV screen.

**Note:** The previous step connects your smartphone, tablet, or computer directly to the TV. No connection charges apply and the connection does not impact your device's data plan.

5. The wireless connection process prompts you for a password. Enter the password as shown on the TV screen.
6. Start the web browser on your mobile phone, tablet, or computer. When you attempt to open any web page, the restricted connection will prompt you for whatever information it needs. In most cases, you must agree to terms and conditions, provide identifying information, or enter a password, PIN, or room number to proceed. The information requested depends on the organization that controls the wireless connection.
7. After you enter the requested information, the TV automatically proceeds to complete its connection and resumes normal operation.
8. If the TV prompts you to link to your Roku account, use your mobile phone, tablet, or computer to activate your Roku TV.

# Using Apple AirPlay and the Apple Home app

## Apple AirPlay

AirPlay lets you share videos, photos, music, and more from your iPhone, iPad, or Mac. To use AirPlay, your Roku TV must be on the same wireless network as your Apple device<sup>1</sup>. To configure your preferred AirPlay security settings, navigate to **Settings > Apple AirPlay and HomeKit** from your Roku TV Home screen. Depending on the AirPlay settings you select, you may be required to enter a password on your Apple device to initiate an AirPlay session on your Roku TV.

## Other AirPlay things to try

- Screen mirroring from an iOS device.
- Screen mirroring from a Mac.
- Using your Roku TV as an extended Mac display.
- Playing synchronized music on multiple AirPlay 2-enabled devices, including Roku TVs.

---

<sup>1</sup> iPhone, iPad, or iPod touch with iOS 12.3 or later. Mac with macOS Mojave 10.14.5 or later.

# Apple Home app

Apple HomeKit controls compatible smart home lights, locks, thermostats, and other devices, including Roku TVs. The Apple Home app lets you add your Roku TV to your Apple HomeKit ecosystem. You can also interact with HomeKit-enabled devices by using Siri from your iPhone, iPad, Apple Watch, HomePod or Mac.

To enable your Roku TV to work with the Apple Home app

1. From your TV's Home screen, navigate to **Settings > Apple AirPlay and HomeKit**.
2. Under **HomeKit**, select **Set Up**. Your TV will display a unique QR code.
3. From your Apple device, open the Apple Home app and select **Add Accessory**.
4. Use the Apple Home app to scan the QR code displayed on your TV and follow the instructions.

## Some Apple HomeKit things to try

On your Apple device, say:

- “Hey Siri, play jazz in the living room.”
- “Hey Siri, mute the TV in the office.”
- “Hey Siri, turn off the TVs in my home.”

Add your Roku TV to an Apple Home scene.

Find more ideas at <https://www.apple.com/home-app/>.

# Adjusting TV settings

You can adjust most picture and sound settings while you are watching a program by pressing **STAR \*** to open the **TV settings** menu. There are some additional picture and sound settings in the main **Settings** menu.

In most cases, the changes you make apply only to the input you are using. Live TV, each HDMI® input, and the AV input have their own settings that the TV remembers when you return to that input. The TV also separately remembers the settings you specify while viewing streaming content.

## Main Settings menu

Use the main **Settings** menu to adjust overall TV settings. Press **HOME**  to go to the Home screen, and then navigate to **Settings > TV picture settings**.

You can adjust the following overall TV picture settings from the **Settings screen**:

- **TV brightness** – Provide a better viewing experience in darker or brighter rooms. Increases or decreases the TV's general brightness across all TV inputs.

**Notes:** Some models have an ambient light sensor that automatically adjusts the brightness of the picture to provide a consistent viewing experience as the lighting in your room changes. Your TV has an ambient light sensor if the **TV brightness** screen has an **Auto** option, which is selected by default. To disable the ambient light sensor, select one of the other **TV brightness** options.

The settings on the **TV brightness** screen are identical to the **TV brightness** settings in the **TV settings** menu that you can access by pressing **STAR \*** while watching a program.

- **HDR/Dolby Vision notification** – Only on certain models: Controls whether the TV displays a notification in the upper right corner of the screen for a few seconds when HDR or Dolby Vision® content begins to play.
  - **On** – The TV displays a notification when HDR or Dolby Vision® content begins to play.
  - **Off** – The TV does not display a notification when HDR or Dolby Vision® content begins to play.

**Note:** This setting does not affect the HDR or Dolby Vision® notification that always appears in the program information banner. Press **OK** while watching a program to open the program information banner.

- **Settings per input** – Lists each enabled TV input. Select an input, and then press **STAR \*** to display the **TV settings** menu where you can adjust the input's settings while watching the video and listening to the sound from that input.

**Tip:** You don't have to go to the main **Settings** menu first—you can display an input's **TV settings** menu and adjust its settings whenever you are watching the input by pressing **STAR \***.



## TV settings menu

The **TV settings** menu provides settings for controlling the appearance of the picture and the quality of the audio for each TV input. To view the **TV settings** menu, press **STAR \*** whenever you are watching a TV input or streaming a video.

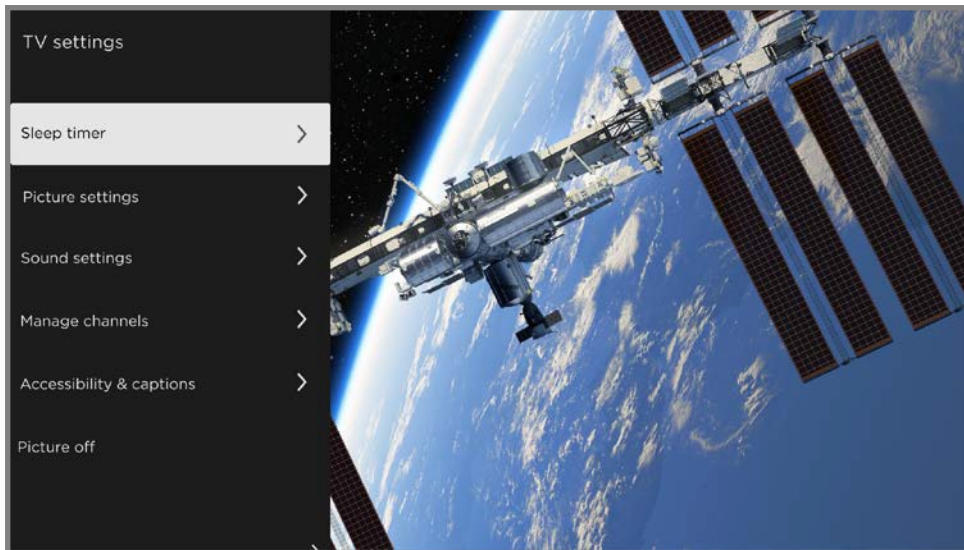

### **TV settings** menu

**Tip:** Some streaming channels assign **STAR \*** to a different function (or no function at all), meaning this button will not open the **TV settings** menu. In these cases, use a different channel, such as The Roku Channel, to configure options. The selected settings remain active for all streaming channels.

Press **UP** or **DOWN** to highlight a setting, and then press **OK** or **RIGHT** to see the options for the setting. You'll see the changes you make right away in picture appearance or audio quality.

- [Sleep timer](#)
- [Picture settings](#)
- [Sound settings](#)
- [Manage channels](#)
- [Accessibility & captions](#)
- [Picture off](#)

**Tip:** To dismiss the **TV settings** menu, just wait a few seconds without pressing any buttons. Or press **STAR \*** again to dismiss the menu immediately.

## Sleep timer

Opens the **Sleep timer** menu where you can set a timer that turns off the TV after the specific amount of time. This setting remains in effect even if you stop watching the current input.

## Picture settings

The **Picture settings** menu adjusts the appearance of the picture for the active input. To access picture settings, press **STAR \*** to display the **TV settings** menu, then select **Picture settings**. The options you see vary depending on the program source.

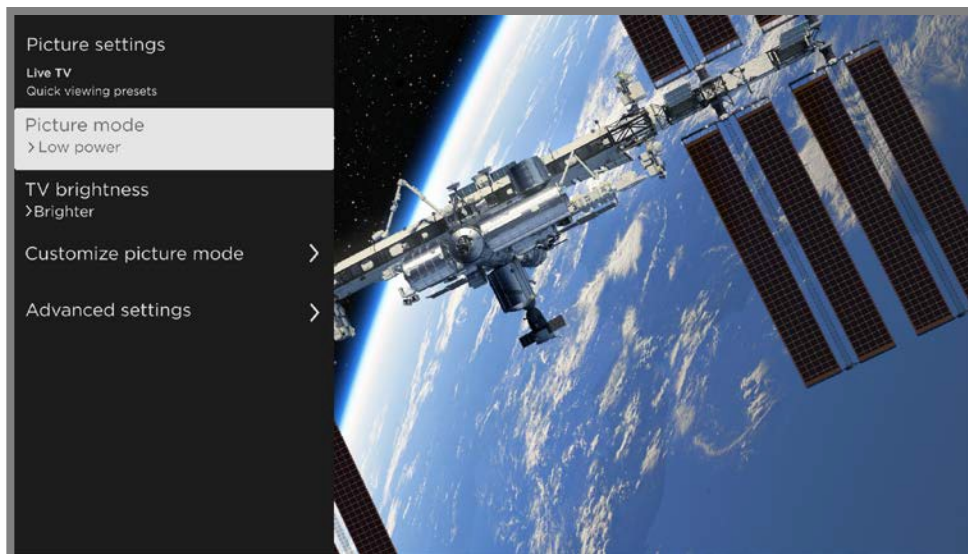

**Picture settings** menu

- **Picture mode** – Picture presets for various viewing preferences. For example, selecting **Vivid** sets **Brightness, Contrast, Sharpness**, and other values to produce a very vibrant picture. Selecting **Movie** changes the settings to produce a picture suitable for enjoying movies in a darkened room.

**Tip:** If you make changes to individual picture settings, these settings are saved for the current input and the current **Picture mode**. In this way you can, for example, individually set the HDMI 1 input's **Movie** picture mode to use different settings than the HDMI 2 input's **Movie** picture mode, and different settings than the Live TV input's **Movie** picture mode.

**Note:** If you change the settings of a **Picture mode**, a small purple dot appears to the right of **Picture mode**.

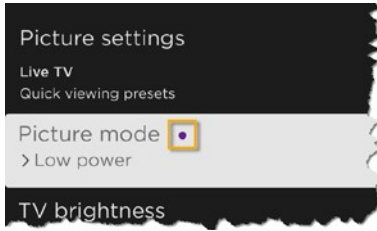

Use *Reset picture settings*, described below, to return the input's selected picture mode to its default settings.

- **TV brightness** – Overall brightness of the picture. This setting applies to all TV inputs and is identical to the *TV brightness* setting under *Settings > TV picture settings*.
- **Customize picture mode** – Opens the [Customize mode name menu](#), where you can adjust various aspects of the picture quality.
- **Advanced settings** – Opens the [Advanced settings menu](#), where you can adjust the advanced features that apply to your TV model.

## Customize Mode name menu options

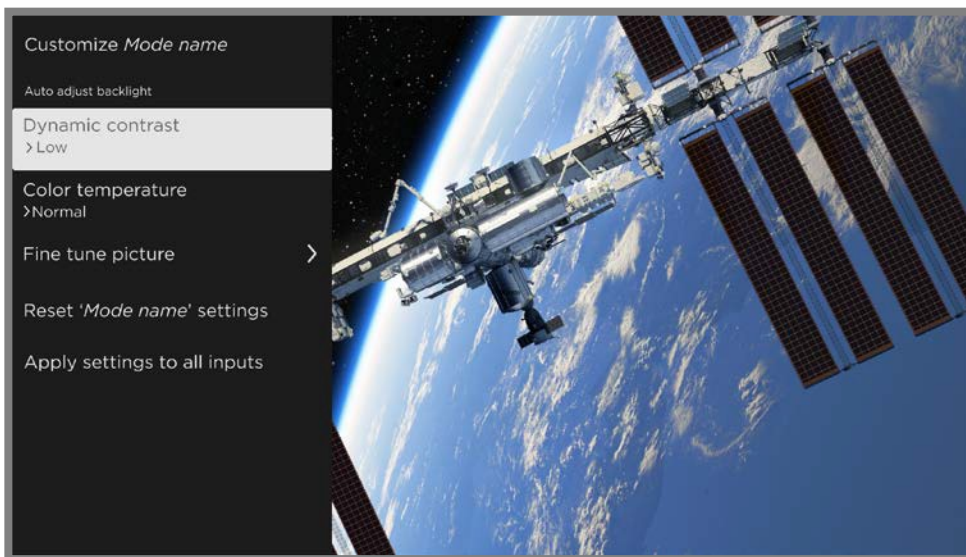

### **Customize Mode name** menu

- **Dynamic contrast** – Only on certain models: Automatically adjusts the backlight level to achieve the optimum contrast and prevent excessive differences between light and dark areas of the screen.

- **Color temperature** – Adjusts the overall color tones in the picture from **Normal** to slightly more bluish (**Cool**) to slightly more reddish (**Warm**).
- **Fine tune picture** – Displays the [Fine tune picture menu](#).
- **Reset ‘mode name’ settings** – Returns all picture settings for the input’s currently-selected **Picture mode** to their original values.
- **Apply settings to all inputs** – Applies the settings you have made in the current **Picture mode** to all TV inputs.

## Fine tune picture menu options

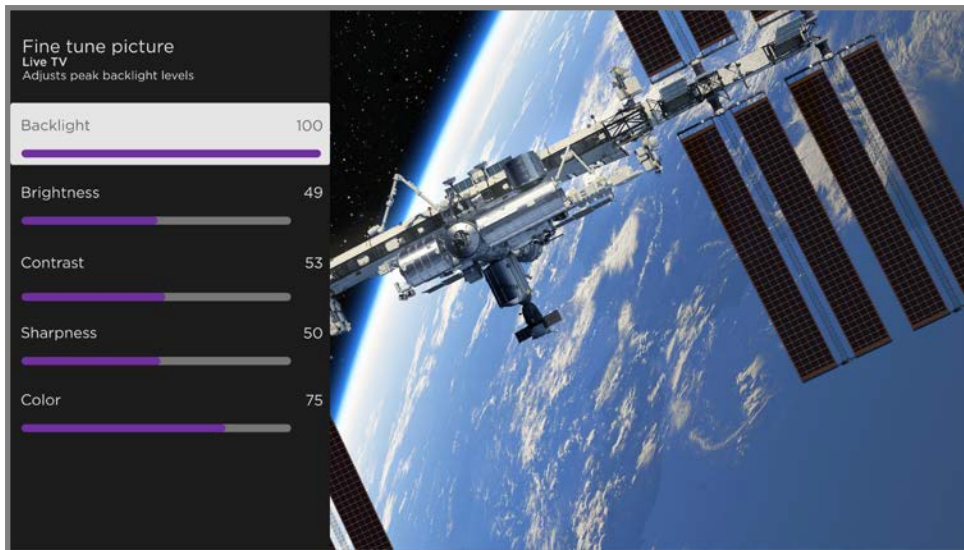

### Fine tune picture menu

- **Backlight** - Adjusts the overall light intensity of the screen.
- **Brightness** - Adjusts the dark level of the picture.
- **Contrast** - Adjusts the white level of the picture.
- **Sharpness** - Adjusts the sharpness of edges in the picture.
- **Color** - Adjusts the saturation of colors in the picture. A setting of 0 removes all color and displays a black and white picture.

## Advanced settings menu options

**Notes:** Certain picture settings vary by brand and model. Not all settings are available on all TVs. Names of certain settings also vary by brand and might differ from the names listed here.



Typical **Advanced settings** menu

- **Picture size** – Aspect ratio of the picture, enabling you to view a picture in its original format, or zoom or stretch it to fill the screen. The **Auto** setting has been found to produce the best picture in most cases.
- **Local dimming** – Only on certain models: Sets the amount of dimming applied to multiple areas of the screen's backlight intensity. This setting can make dark areas darker without affecting the brightness of light areas.
- **Micro contrast** – Only on certain models: Improves image contrast.
- **Action Smoothing** – Only on certain models. Your model might use a different name for this option. Adjusts the amount of motion processing applied to the video signal. A higher setting results in more smoothing, but can cause undesirable picture artifacts in certain types of content. Each **Picture mode** has a different default setting.

- **Natural Cinema** – Only on certain models. Your model might use a different name for this option. Reduces “judder” often present when 24 frame-per-second movies are upscaled to TV standard frame rates. **Natural Cinema** mode is **On** by default in **Movie** and **HDR Dark** modes, and **Off** by default in other modes.
- **Action Clarity** – Only on certain 120Hz models. Your model might use a different name for this option. Reduces blur in fast-moving images such as sports.
- **LED Motion Clarity** – Only on certain models that also have the local dimming feature. Your model might use a different name for this option. Reduces motion blur caused by the screen refresh rate. Enabling this feature inserts black frames between picture frames, providing viewing improvements for fast moving games and sports, but reducing the brightness of the picture. Select **Low**, **Medium**, **High**, or **Off** to achieve the desired picture quality balance.
- **Tint** – Adjusts the color balance from green to red to obtain accurate colors in the picture.
- **Game mode** – Only on HDMI<sup>®</sup> and AV inputs: Enables less image processing resulting in less input lag, which improves viewing of action games. Also see [Variable refresh rate \(VRR\)](#).
- **Auto low latency mode (ALLM)** – Only on certain models: Detects when certain game consoles are connected to an **HDMI** input, and then automatically configures the best settings when that input is selected. When ALLM is active, the manual **Game mode** setting is not available. Note that there is no ALLM menu option.

## Variable refresh rate (VRR)

Only on certain models: Variable refresh rate (VRR) allows a compatible game console or computer connected via HDMI to control the refresh rate of the TV. This feature helps to ensure that the TV does not begin to display a video frame until the video source has completely rendered it. The result is smoother image animation with a lower instance of stutter or tearing. This feature requires the following conditions:

- **Variable refresh rate** is turned **On** in the HDMI settings for the input. This setting is **Off** by default.
- The **HDMI mode** is set to **Auto** or **HDMI 2.0** in the HDMI settings for the input.
- **Game mode** is enabled.
- The connected device supports VRR.

# Sound settings

The **Sound settings** menu adjusts the sound qualities of the TV. To access sound settings, press **STAR \*** to display the **TV settings** menu, then select **Sound settings**.

**Note:** Most sound settings do not affect the sound that you hear from a connected receiver or headphones. Also, the **Sound settings** option is unavailable when you are using the private listening feature through the Roku mobile app or (on certain models) through a Roku Voice Remote or Bluetooth headphones.

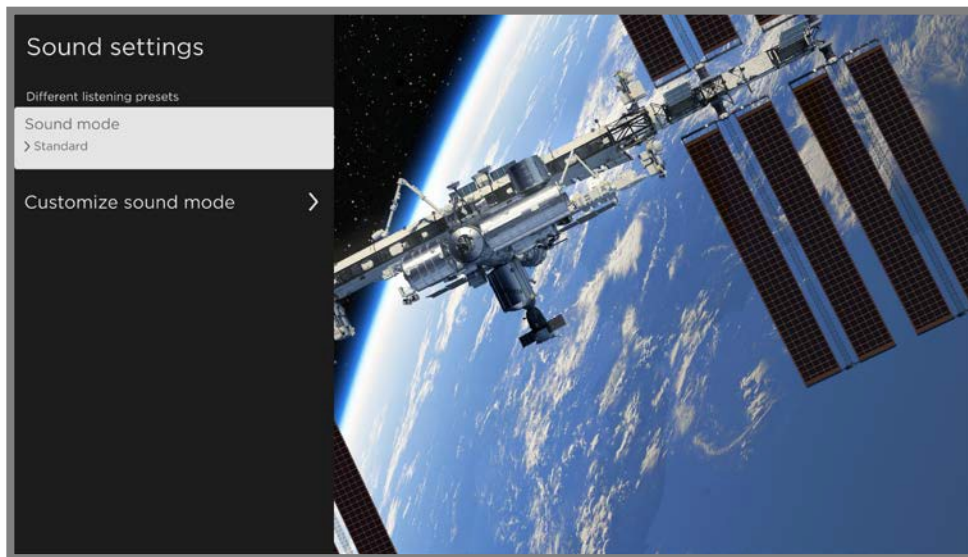

**Sound settings** menu

- **Sound mode** – Preset sound modes to make programs sound their best.
- **Customize sound mode** – Opens the [Customize mode name menu](#), where you can adjust various aspects of the sound according to the features available on your TV model.



## Customize Mode name menu options

Your TV model might have any one of the following sound settings available in the **TV settings** menu

- [Dolby® Audio Processing](#)
- [DTS® TruSurround / DTS® Studio Sound](#)
- [Sonic Emotion™ Premium](#)
- [Volume mode](#)
- [Roku premium audio products](#)

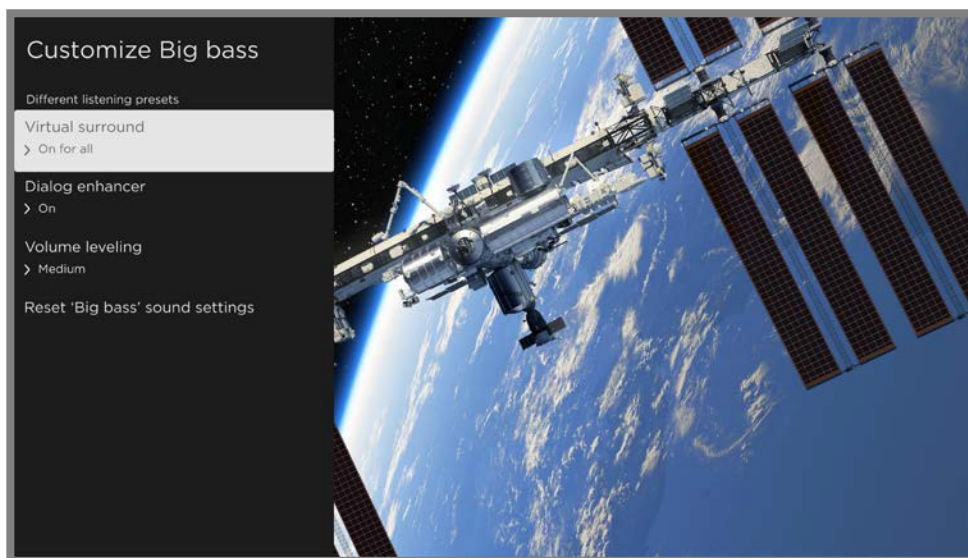

Typical **Customize Mode name** menu

## Dolby® Audio Processing (certain models only)

- **Virtual surround** (Only on certain models) – Simulates surround sound. Sometimes the effect interferes with dialog clarity. Use the **Dialog enhancer** option to compensate.
- **Dialog enhancer** – Improves the clarity of speech.
- **Volume leveling** – Smooths out the high and low sounds.
- **Dolby AC-4 Dialog Enhancement** – Only on certain models: Enhances dialog in content that supports the AC-4 audio format.

- **Reset ‘Sound mode’ sound settings** – Returns **Virtual surround, Dialog enhancer**, and **Volume leveling** settings to their default settings for the selected **Sound mode**.

**Note:** Dolby Atmos® decoding is available only when using the built-in TV speakers. Is not available when using external speakers.

## DTS® TruSurround / DTS® Studio Sound (certain models only)

- **DTS TruSurround** – Simulates surround sound. Sometimes the effect interferes with dialog clarity. Use the **Dialog clarity** option to compensate.
- **Dialog Clarity** – Improves the clarity of dialog when you are using the DTS TruSurround feature.
- **TruVolume** – Minimizes annoying volume fluctuations in programs.
- **Dolby AC-4 Dialog Enhancement** – Only on certain models: Enhances dialog in content that supports the AC-4 audio format.
- **Reset ‘Sound mode’ sound settings** – Returns **DTS TruSurround, Dialog Clarity**, and **TruVolume** settings, to their default settings for the selected **Sound mode**.

## Sonic Emotion™ Premium (certain models only)

- **Sonic Emotion Premium** – Displays a menu with individual Sonic Emotion™ audio settings:
  - **Dialog Enhancement** – Enhances your ability to hear and understand dialog in the program.
  - **Bass Enhancement** – Enhances the low frequency sound component in the program.
  - **Absolute 3D Sound** – Simulates surround sound.
- **Dolby AC-4 Dialog Enhancement** – Only on certain models: Enhances dialog in content that supports the AC-4 audio format.

- **Reset 'Sound mode' sound settings** – Returns **Sonic emotion** settings to their default settings for the selected **Sound mode**.

## Volume mode (certain models only)

- **Off** – Content volume is unmodified.
- **Leveling** – Provides a consistent volume level across different types of content.
- **Night** – Soft sounds are increased while loud sounds are decreased, making it easier to hear your TV at night without disturbing others.
- **Dolby AC-4 Dialog Enhancement** – Only on certain models: Enhances dialog in content that supports the AC-4 audio format.

## Roku premium audio products

Several different Roku premium audio products are available for separate purchase. You can connect them to any Roku TV model. When you do, the **Sound settings** menu on the TV provides direct access to the sound settings of the connected Roku audio product(s). For more information, see [Roku TV soundbars and wireless speakers](#).

Although the sound settings vary depending on the connected product and its current feature set, following are examples of typical settings that you can control directly from your TV:

- **Volume mode** – Modes for normal listening, volume leveling, and night listening.
- **Speech clarity** – Makes voices easier to hear above the rest of the program.
- **Expanded stereo** – Simulates surround sound or, only with Roku wireless speakers in a supported surround configuration, play stereo sound from all speakers.
- **Bass** – Adjusts the level of low frequency sounds.
- **Treble** – Adjusts the level of high frequency sounds.
- **Surround level** – Only if you have Roku wireless speakers in a supported surround configuration, sets the surround volume level to your liking.

- **Virtual surround** – Only if you do not have Roku wireless speakers in a surround configuration, enhances the stereo sound from the soundbar to simulate surround sound.
- **Dolby AC-4 Dialog Enhancement** – Only on certain models: Enhances dialog in content that supports the AC-4 audio format.
- **Reset sound settings** – Returns all sound settings to their defaults for the selected **Sound mode**.

## Manage channels

Designate favorite channels and edit your channel lineup in the **Manage Channels** menu. You can navigate to the **Manage Channels** menu in several ways:

- From the Home Screen Menu, navigate to **Settings > TV inputs > Live TV > Manage channels**, and then select **Manage all channels** and press **OK**.
- While watching a live TV program, press **STAR \*** to display the **TV settings** menu, and then navigate to **Manage channels** and press **OK**.
- While using the Live TV Channel Guide, navigate left to the channel column, and then press **STAR \***. In the **Channel options** dialog, highlight **Manage channels** and press **OK**.
- While using the Live TV Channel Guide, navigate left past the channel column to the Live TV Categories column. Scroll up or down to **Favorites**, press **RIGHT** to highlight **Select to add favorite channels**, and then press **OK**.

In the **Manage Channels** menu, select **Favorite channels** or **Edit channel lineup**.

## Favorite channels

Use the **Favorite channels** menu to designate any number of channels as your favorites.

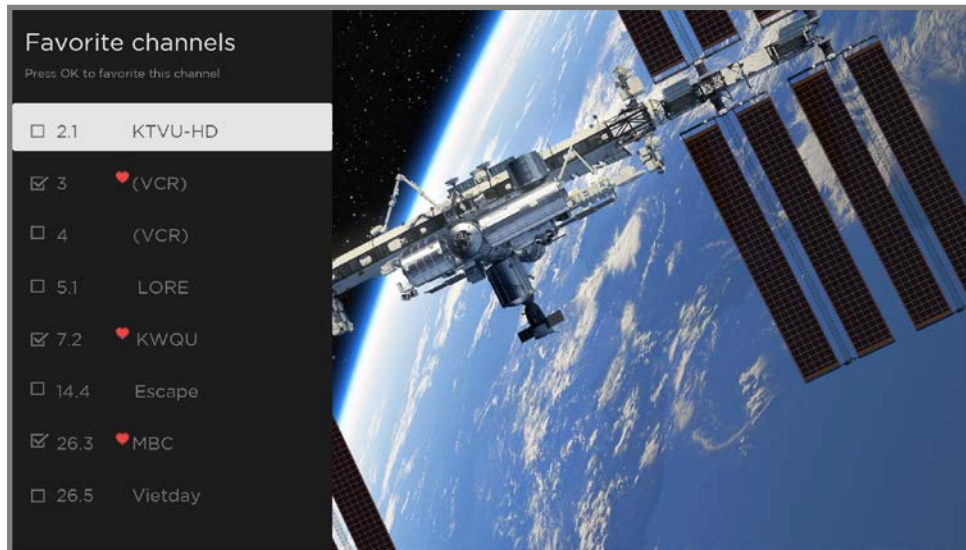

Press **UP** or **DOWN** to highlight a channel, and then press **OK** to select or clear its check box. A **FAVORITE** ❤️ symbol appears next to each channel you designate as a favorite.

**Tip:** Pause for a few seconds for the TV to tune to the highlighted channel. You then can view and hear the channel to decide whether you want to make it a favorite.

**Note:** If you've enabled parental controls and the program on the current channel is blocked, you won't see a picture or hear sound while using the *Favorite channels* menu.

To switch between surfing all channels and favorite channels, select Favorites in the filter column of the Live TV Channel Guide.

## Edit channel lineup

When you scan for channels described in [Setting up live TV](#), the TV adds all the channels with good signals that it can detect in your area. In addition, unless you hide them as explained in [Hide streaming TV channels](#), the channel lineup will include streaming channels along with your local TV stations.

At this point, you might have more channels than you want in your channel list. Use the **Edit channel lineup** menu to hide any channels that you do not want in your channel list. You can hide both over-the-air and streaming TV channels.

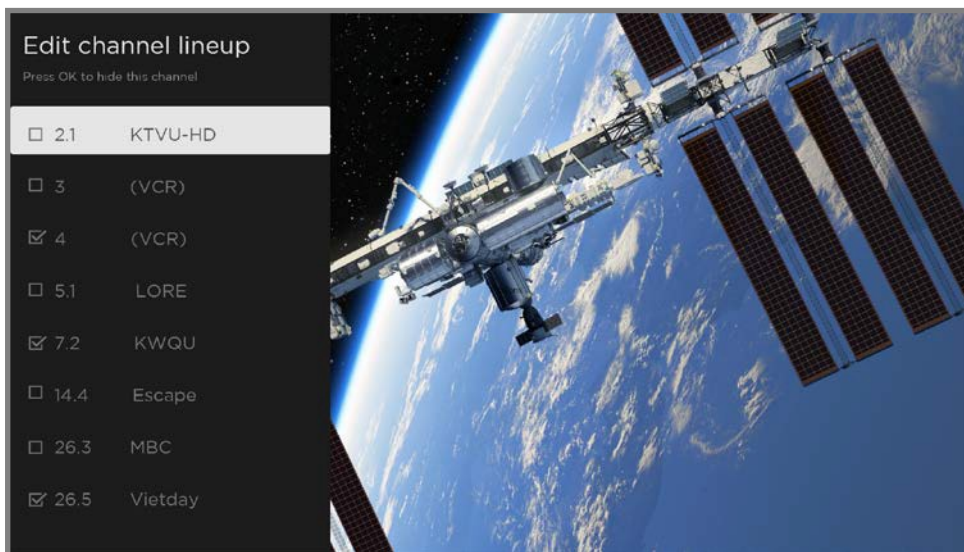

Press **UP** or **DOWN** to highlight a channel, and then press **OK** to select or clear its check box. Channels with check marks are hidden in the Live TV Channel Guide and cannot be tuned.

**Tip:** Pause for a few seconds for the TV to tune to the highlighted channel. You then can view and hear the channel to decide whether you want to hide it. If you've enabled parental controls and the program on the current channel is blocked, you won't see a picture or hear sound while using the *Edit channel lineup* menu.

**Note:** Repeating the live TV channel scan unhides all hidden channels.

## Hide streaming TV channels

By default, the Live TV Channel Guide shows both over-the-air channels and streaming channels in one long list. If you prefer, you can hide streaming channels from the Live TV Channel Guide.

To hide streaming TV channels, from the Home Screen Menu, navigate to **Settings > TV inputs > Live TV > Manage channels**, and then highlight **Hide streaming TV channels** and press **OK** to select the adjacent check box.

## Accessibility & captions

The settings on the **Accessibility & captions** menu enable you to change the TV's accessibility settings without leaving the program you are watching. These settings are also available in the **Home Screen Menu** under **Settings > Accessibility**.

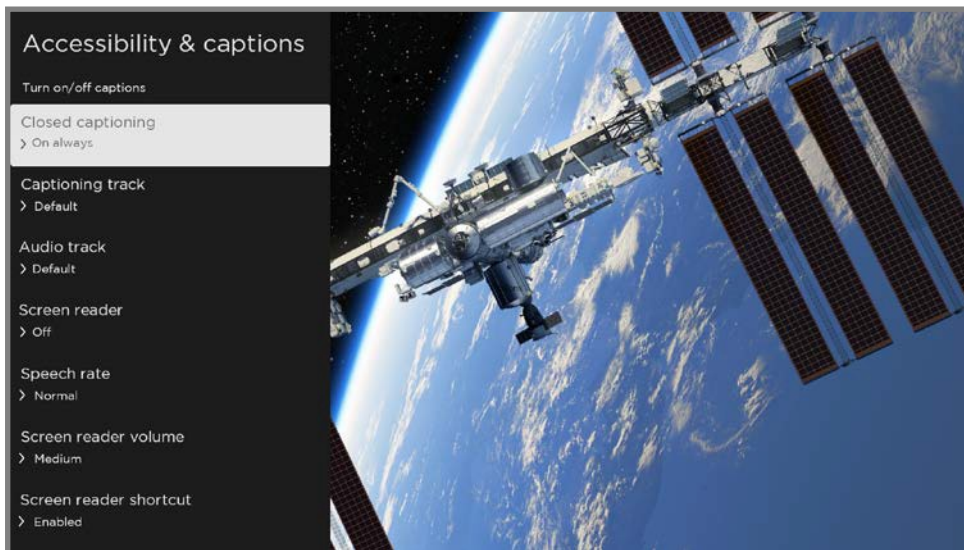

Typical **Accessibility & captions** menu

**Tip:** Some streaming channels assign **STAR \*** to a different function, meaning it will not open the **TV settings** menu. In these cases, use a different channel, such as The Roku Channel, to configure accessibility options.

## Accessibility & captions menu settings

- **Closed captioning** – Controls when you see captions. This setting appears only for programs you watch through **ANT**, **AV**, streaming, and Roku Media Player. Any set value remains in effect across only these inputs.
  - **Live TV** – Set captions to **Off**, **On always**, **On replay**, or **On mute**.
  - **AV input** – Set captions to **Off**, **On always**, **On replay**, or **On mute**.
  - **Streaming video channel and Roku Media Player** – Set captions to **Off**, **On always**, **On replay**, or **On mute**. Not all streaming content has captions. Note that some streaming channels have other methods for turning captions on and off. In these cases, the **Closed captioning** option does not appear on the **TV settings** menu.
- **Captioning track** – Selects which caption track to display when closed captioning is on. This setting remains in effect on all inputs that provide captions.
- **SAP** – Select whether to play a secondary audio program or multichannel television sound, and which choice to play. See [Video description through Secondary Audio Program \(SAP\)](#). This setting applies only to live TV on digital channels.
- **Audio track** – Select the audio track to play with the current program. This setting applies only to streaming content when multiple audio tracks are available.
- **Screen reader** – Turn the screen reader on or off. The screen reader is a text-to-speech user interface to help you navigate the Roku user interface. When enabled, it reads out text, menus, and other on-screen items.

**Accessibility:** If *Screen reader shortcut* is enabled, you can enable or disable the screen reader by pressing the **STAR \*** four times in quick succession. (**STAR \*** is located directly below the purple directional pad on the right side of the Roku remote.)

- **Speech rate** – Select the speed at which the screen reader speaks.



- **Screen reader volume** – Set the volume of the screen reader in relation to the main TV volume.
- **Screen reader shortcut** – Enable or disable the screen reader shortcut feature. When disabled, pressing **STAR \*** four times in quick succession does not enable or disable the screen reader.

## Video description through Secondary Audio Program (SAP)

Video description of the action in a program helps individuals who are blind or visually impaired enjoy programs. You enable video description by selecting one of the Secondary Audio Program (SAP) options.

To hear video description narrations in programs that have them, turn on **SAP**. If there are multiple **SAP** options for a channel, such as **Spanish** and **French**, try each one to determine which setting carries the video description track.

**Accessibility:** Broadcasters provide video descriptions only on a small number of programs. If you are unable to hear video descriptions after following these instructions, the program you are viewing does not provide them.

For more details about video description, go to:

<https://www.fcc.gov/consumers/guides/audio-description>

## Picture off

Select **Picture off** to turn off the screen while continuing to play the sound. You might want to use this feature when listening to music or podcasts, or at any other time that you do not want to see the TV screen.

When you want to turn the picture back on, press **OK**. Or, if you turn off the TV while the screen is off, it comes on again the next time you turn on the TV.

# Featured Free

Use **Featured Free** to discover content that is free to watch.

As you browse through the programs, the featured channel's icon appears in the upper left corner of the screen. Use the purple directional pad to highlight a program, and then press **OK** to see more information about it.

While you are viewing a program's details, press **OK** to start playing the program. If you've already added the channel, you'll be taken directly to the channel and the program will begin to play. If you have not added the channel, it will be added for you before playing the program.

If you don't want to see Featured Free in the Home Screen Menu, you can hide it.

To hide **Featured Free**:

1. From the Home Screen Menu, navigate to **Settings > Home screen**, and then press **RIGHT**.
2. Select **Featured Free**.
3. Highlight **Hide**, and then press **OK**.

# Searching for something to watch

Searching for movies and programs across streaming channels and live TV is one of the unique features of your Roku TV. Within a single search operation, you can search by:

- Movie name
- TV program name
- Actor or director name
- Streaming channel name
- Interactive game name
- Music or podcast title or artist on Spotify
- Genre, including the special genres, “free” and “4K.”

**Note:** Roku Search searches across many, but not all, popular streaming channels. The actual channels it searches vary by locale.

## How do I search?

You can search in several different ways:

- By speaking search phrases in English, Spanish, Portuguese, or German (corresponding to your selected TV language setting) using a Roku Voice remote, the Roku mobile app, Amazon Alexa, or Google Home Assistant. Participating channels show results without leaving the channel you are viewing. Results from the channel you’re currently watching appear in the first row, followed by results from other channels.
- By using an on-screen keyboard that you navigate using the purple directional pad on your remote
- By typing on the Roku mobile app on your phone or tablet

For more details about Voice Search, go to [go.roku.com/voicesearch](https://go.roku.com/voicesearch).

# Voice Search from a Roku Voice remote

Only with models that have a Roku Voice remote:

1. Press and hold either **VOICE**  or **SEARCH** , or say “Hey Roku,” depending on your remote.

**Hint:** Tap the button to see on-screen tips about searching. Repeat to see a different set of tips.

2. While holding down the button, say the name of a movie, TV program, actor, director, or genre (including the special genres, “free” and “4K”). You also can search for news programs. Say things like, “Show the news,” “Play news,” or “Play news on newsy.”

**Note:** You can use English, French, Spanish, Portuguese, or German for voice searches, according to the TV language you set in **Settings > System > Language**.

The TV lists the results of your search across many streaming channels and live TV channels.

3. Press **RIGHT** to move the highlight into the list of search results.
4. Press **UP** or **DOWN** to scroll through the list of search results to highlight the item you want to view.

## Searching from the Roku mobile app

Use the free Roku mobile app on your compatible smartphone or tablet to make searching even faster. Use your mobile device’s keypad to type more quickly and easily than with the on-screen keyboard on your TV. Or search by touching the Voice Search icon and saying the name of the movie, TV program, actor, director, genre, streaming channel, or game.

When you use the Roku mobile app to search, search results are shown on your mobile device instead of on the TV screen. When you make a selection from the search results, the TV starts playing the selected program.

For more information, see [Roku mobile app](#).

## Searching with Google Assistant

Use your Google Home, Google Pixel phone, or the Google Home mobile app to search for programs:

1. Link your Roku account to your Google account using the Google Home mobile app on your iOS or Android device.
2. Start your command with “Hey Google” or “OK Google,” and follow the command with “on Roku.” Some examples:
  - “Hey Google, show me documentaries on Roku.”
  - “OK Google, show me comedies on Roku.”

**Note:** You also can issue commands to control your Roku TV. And, if you have enabled *Fast TV Start* on your TV, you can turn on your TV by saying, “OK Google, turn on Roku.”

For more information about setting up and using Google Assistant with your Roku TV, see the Roku support article, [How to use Google to control your Roku® streaming device](#).

## Searching with Amazon Alexa

Use your Amazon Echo Dot, Echo Plus, Echo Show, or the Amazon Alexa mobile app to search for programs:

1. Link your Roku account to your Amazon account using the Amazon Alexa app on your iOS or Android device.
2. Start your command with “Alexa,” and follow the command with “on Roku.” Some examples:
  - “Alexa, turn up the volume on Roku.”
  - “Alexa, show me documentaries on Roku.”

**Note:** You also can issue commands to control your Roku TV. And, if you have enabled *Fast TV Start* on your TV, you can turn on your TV by saying, “Alexa, turn on Roku.”

For more information about setting up and using Amazon Alexa with your Roku TV, see the Roku support article, [How to use Amazon Alexa to control your Roku® streaming device](#).

## Keyboard search using the remote

1. Select **Search** from the Home Screen Menu.
2. Use the purple directional pad to navigate the on-screen keyboard, entering a few characters of the search term.

Each additional character you enter narrows down the search, making the search results more relevant. You'll often see the results you are seeking after entering only a few letters.

3. When you see the program you are searching for, press **RIGHT** to highlight it. Continue pressing **RIGHT** to see more details about how to watch the program.

## Direct-to-playback search results

With direct-to-playback, voice search results jump directly to and start playing the program whenever your search command can be uniquely identified and the requested content is available at no additional cost to you.<sup>1</sup>

## Searching for free content

You'll discover an almost endless list of content through your Roku TV, and much of it is free. You can easily find free content by including the word "free" in your search.

For example:

- **Roku Voice Remote or Roku mobile app**—Say, "Show me free comedies" or "Show me free romance," or simply, "Show me free shows."
- **Google Home, Google Pixel phone, or the Google Home mobile app**—Say "OK Google, show me free programs on Roku," or "Hey Google, show me free documentaries on Roku."
- **Amazon Alexa**—Say "Alexa, show me free miniseries on Roku" or "Alexa, show me free dramas on Roku."

---

<sup>1</sup> Direct-to-playback commands work with selected streaming channels. Direct playback occurs only when there is a high confidence of match, the content is free or you are already subscribed, and the channel is already added to your Home screen.

# Using the Roku Store

From the Home Screen Menu, navigate to **Streaming Channels** option to go to the Roku Store, where you can select new free and subscription based streaming content.

When you find an item you want to add or learn more about, highlight it and press **OK** to display more details.

- If the content is free, you can select it to start watching it immediately.
- If there is a one-time or recurring fee associated with using the content, you must agree to the terms and conditions, accept the fee, and enter your Roku Account PIN to authorize these charges.
- If you already have a subscription to the content—for example, you already subscribe to Netflix or you receive HBO through your cable TV provider—you must complete a different, simple authorization step to watch it on your Roku TV.

Content availability and pricing are subject to change. Charges may apply to your selection.

**Tip:** New content is continuously added to the Roku Store, so be sure to check back frequently for new options.

**Note:** If you don't remember your PIN, or if you want to change whether you need to use a PIN to make purchases on your Roku account, see [Roku Account PIN](#).

## Automatic Account Link

Some streaming subscription channels take advantage of Automatic Account Link. If you have multiple Roku devices, channels that support this feature require you to supply your user name and password on only one device. For a growing list of channels that support this feature, see the Roku support article, [How to set up, or sync, subscription channels in your account on a second Roku® streaming device](#).

# Customizing your TV

There are many things you can do to personalize your TV.

## Add TV inputs to your Home screen

As you use your TV, you might find that you need to add a TV input that you did not add during Guided Setup. To add a TV input:

1. From the Home Screen Menu, navigate to **Settings > TV inputs**. Notice that the list of inputs is divided into two sections: **Inputs being used** and **Inputs not used**.
2. Press **UP** or **DOWN** to highlight an input in the **Inputs not used** section of the list.
3. Press **RIGHT** to move the highlight to **Set up input**.
4. Press **OK** to add the input.
5. Press **HOME**  to return to the Home screen. Notice that the input has been added to the top of the Home screen. If you want to move the input to a different position in the grid, see [Rearrange inputs and channels](#).

**Tip:** If you purchase and connect a Roku premium audio product, such as a Roku Streambar<sup>®</sup>, your Roku TV automatically controls all required sound settings, power, volume, and mute through your TV's remote control.

## Add streaming channels to your Home screen

You can add streaming channels by searching in the Roku Store.

Streaming channels that you add appear at the bottom of the Home screen. If you want to move a channel to a different position, see [Rearrange inputs and channels](#).



**Hint:** If you have multiple Roku devices, they will all show the same set of streaming channels after their next daily update, except for channels that are not compatible with the device. So don't be surprised when you add a channel to your Roku TV and then see it the next day on your other Roku streaming devices.

## Rename inputs

When you connect and power on an HDMI® device, your TV identifies it, automatically renames the input, and changes the icon to suit the device.

For other inputs, and for inputs whose automatic naming you do not like, you can change the name and icon. To select a different name and icon for an input, you can either:

- Highlight the input on the Home screen, and then press **STAR \*** to display a list of options. From the list of options, select **Rename input**. Then select a new name and icon.

or

- From the Home Screen Menu, navigate to **Settings > TV inputs**. On the **TV inputs** screen, select the input you want to rename, select **Rename**, and then select a new name and icon from the provided list.

## Custom input names/icons

Rather than using predefined names and icons, you can enter a custom name and select an icon. From the **Rename** list, scroll down to **Set name & icon**, and then press **OK**. Follow the instructions on the screen to enter a name and select an icon for the input.

Press **HOME**  to return to the Home screen. The new name and icon are now in effect.

## Remove unwanted inputs and channels

If you never use a TV input or if you don't like the streaming channel you added from the Roku Store, you can remove the item from your Home screen.

**Note:** Be aware that removing the *Live TV* input deletes your channel list, so you'll have to scan for channels again if you later re-add the input. See [Setting up live TV](#) for details.

To remove an input or channel, you can either:

- Highlight the input or channel tile on the Home screen, and then press **STAR \***. From the list of options, select **Remove input**. In the screen that follows, confirm you want to remove the item.

or

- Navigate to **Settings > TV inputs**. On the **TV inputs** screen, select the input you want to remove, and then select **Remove > Confirm**. Press **HOME**  to return to the Home screen.

## Rearrange inputs and channels

Adding a TV input adds it at the top of the Home screen. Adding a streaming channel adds it at the bottom of the Home screen.

You can rearrange the order of the inputs and channels on your Home screen to suit your viewing preferences. For example, you might want **Live TV** to be the first item in your Home screen. But if you mostly watch one streaming channel, you might want it to be the first one on your Home screen.

1. On the Home screen, highlight an input or channel tile you want to move.
2. Press **STAR \*** to display a list of options for the item you selected.
3. Select **Move input** or **Move channel**. The list of options closes and the highlighted item shows arrows indicating how it can be moved.



4. Use the purple directional pad to move the highlighted item to its new position.
5. Press **OK** to lock the item into its new position.
6. Repeat these steps to move other inputs and channels until you have arranged your Home screen to your liking.

## Change the look and feel with themes

Another way to customize your TV is to change its theme. The theme establishes the look, feel, and sounds of the TV through colors, designs, fonts, wallpaper (background), screensaver, and menu navigation sounds.

To change the theme, from the Home Screen Menu navigate to **Settings > Theme**. In the **Themes** screen, choose from the following options:

- **Theme packs** – Choose from a selection of packages that include coordinated wallpapers, screensavers, and sounds.
- **Wallpapers** – Select a wallpaper of your choice.
- **Screensavers** – Select a screensaver of your choice.
- **Sounds** – Select a sound set of your choice.

- **Seasonal wallpapers** – When this feature is on, Roku overrides your selected wallpaper with a wallpaper of their own choosing for various holidays and significant events. After the holiday or event passes, the TV reverts to your selected theme.
- **Sponsored wallpapers** – When this feature is on, Roku occasionally overrides your selected theme with themes that celebrate TV shows, movies, and events.
- **Wallpaper animations** – When this feature is on, certain wallpapers display entertaining animated features.
- **Screensaver start time** – Select the idle time after which you want your selected screensaver to appear, or disable the screensaver.
- **Restore default theme** – Every Roku TV has a theme based on the TV brand and model. Use this option to restore that default theme.

## Change menu volume

Menu sounds are the sounds the TV makes to let you know it received your command. You can change the volume of these menu sounds or turn them off.

To adjust the menu volume, from the Home Screen Menu, navigate to **Settings > Audio > Menu volume**. Navigate to the right and then change the setting to **High, Medium, Low, or Off**.

# Configure power settings

Power settings configure features related to how your TV's power settings work.

## Power on settings

Power on settings tell the TV what to do when you turn on the power. To configure the power on settings, from the Home Screen Menu, navigate to **Settings > System > Power > Power on**. Highlight the preferred power on location in the list, and then press **OK**.



## Auto power savings

To help you save energy, your TV can automatically turn itself off after a period of inactivity or a period during which no signal has been detected. It is factory-configured to do both of these things, but you can change these settings if needed.

To configure automatic power off, from the Home Screen Menu navigate to **Settings > System > Power > Auto power savings**. In the **Power settings** screen, highlight the following options and press **OK** to turn them on or off:

- **Reduce power after 15 minutes** – If no video or audio activity and no user interaction occur for 15 minutes, the TV automatically turns off the screen and sound.
- **Turn off after 4 hours** – If no video or audio activity and no user interaction occur for 4 hours, the TV goes into standby mode.

## Standby LED On/Off

Normally, the status indicator is lit whenever the TV is in standby mode. If you prefer the status indicator to not be lit in standby mode, you can turn it off. To do so, from the Home Screen Menu, navigate to **Settings > System > Power > Standby LED**, and then select **Off**.

After making this change, the status indicator still performs all other indication functions.

## Fast TV start

Only on certain models, you can enable **Fast TV start**, which lets you start watching your TV almost instantly after turning it on. **Fast TV start** also enables other convenient features, such as the ability to listen to certain music channels with the TV screen off and the convenience of being able to turn on and control your TV using voice commands.

To enable Fast TV Start, on the Home screen, navigate to **Settings > System > Power > Fast TV Start** and select **On**.

Be aware that enabling **Fast TV start** makes your TV use somewhat more power when it is in standby mode.

# Configure accessibility

Accessibility settings enable users with vision or hearing impairment to use the TV more effectively. Accessibility settings are located under **Settings > Accessibility**.

## Captions mode

- **Off** – No captions appear.
- **On always**– Captions appear whenever they are available from the program source.
- **On replay**– Captions appear only when you use the replay feature, and only when you are watching a streaming program that supports instant replay, watching a video through the Roku Media Player, or watching a TV channel after enabling Live TV Pause.
- **On mute** – Captions appear only when the TV is muted.

**Tip:** You can also change the captions mode while watching a program. Press **STAR \*** to display the *TV settings* menu, and then select **Accessibility & captions > Closed captioning**. However, note that some streaming channels require you to enable captions through a setting within their channel even though you have turned on captions elsewhere.

**Note:** Once enabled, the captions mode applies to all inputs that support captions and remains enabled until you turn it off.

**Tip:** If you have a Roku Voice Remote or the Roku mobile app, you can use a voice command to turn captions on or off. For example, just say, “Captions on,” “Captions off,” “Captions replay,” or “Captions on mute.”

## Captions preferred language

Use the **Captions preferred language** setting to select the language in which you want closed captioning to appear, when that language is available. If your preferred language is not available, then captioning reverts to the default language for the program, which usually is English.

Highlight the language you prefer, and then press **OK** to select it.

## Captions style

- **Text style** - Choose from a list of fonts. As you move the highlight to each font, you can see a sample of the result in an adjacent panel.
- **Text edge effect** - Choose from a list of edge effect styles, such as raised, depressed, and various shadows. As you move the highlight to each effect, you can see a sample of the result in an adjacent panel.
- **Text size** - Choose from a list of sizes. As you move the highlight to each size, you can see a sample of the result in an adjacent panel.
- **Text color** - Choose from a list of colors for the text. As you move the highlight to each color, you can see a sample of the result in an adjacent panel.
- **Text opacity** - Choose from a list of opacity settings for the text. This setting determines how much the area behind the text shows through the text. A value of 100% blocks all of the content behind the text. As you move the highlight to each setting, you can see a sample of the result in an adjacent panel.
- **Background color** - Choose from a list of colors for the background area behind the text. As you move the highlight to each color, you can see a sample of the result in an adjacent panel. Note that you won't see any change unless you set the **Background opacity** to a value other than **Off**.
- **Background opacity** - Choose from a list of opacity settings for the background of the caption. This setting determines how much the area behind the caption background shows through the background. A value of 100% blocks all of the content behind the background. As you move the highlight to each setting, you can see a sample of the result in an adjacent panel.
- **Window color** - Choose from a list of colors for the window rectangle surrounding the entire caption. As you move the highlight to each color, you can see a sample of the result in an adjacent panel. Note that you won't see any change unless you set the **Window opacity** to a value other than **Default** or **Off**.
- **Window opacity** - Choose from a list of opacity settings for the window rectangle surrounding the entire caption. This setting determines how much the area behind the caption window shows through the window. A value of 100% blocks all of the content behind the window. As you move the highlight to each setting, you can see a sample of the result in an adjacent panel.



## Screen reader settings

Screen reader settings help users who are blind or visually impaired to configure the text-to-speech reader, enabling them to operate their TV more easily. The screen reader uses voice prompts that speak volume and channel changes, menu options, and setting changes. Access screen reader settings from the Home Screen Menu by navigating to **Settings > Accessibility**, and then set the various options as desired in the **Screen reader** section.

## Customize the Home screen

If you prefer to not see certain features on the Home screen, you can hide them. From the Home Screen Menu, navigate to **Settings > Home screen**, and then press **RIGHT**. Select either **Hide** or **Show** for each of the available options.

**Note:** The items you can hide or show vary by locale and might change over time.

# Parental controls

Parental controls enable you to decide whether the members of your household can view certain kinds of broadcast TV programs. When a program is blocked, you can unblock it by entering a PIN that only you know.

**Note:** Parental controls block content from the TV tuner. Parental controls do not block content on other TV inputs or content from streaming channels you add to your TV.

## Creating a parental control PIN

You create a new parental control PIN the first time you access the **Parental controls** screen on your TV.

1. From the Home Screen Menu navigate to **Settings > Parental controls**. The screen displays a numeric keypad.
2. Press **RIGHT** to highlight the numeric PIN entry number pad.
3. Use the on-screen number pad to enter a four-digit code, and then press **OK**.
4. Repeat the process to enter the same PIN again, just to make sure you correctly entered the PIN you want to use.
5. Press **OK** to proceed to the **Parental controls** screen where you configure the types of programs to block.

# Blocking broadcast TV programs

For broadcast TV, parental controls use information embedded in the broadcast signal to determine whether to allow a program to be displayed. Parents can configure parental controls to block broadcast TV programs that meet or exceed a specific rating, so they cannot be viewed or heard unless the correct parental control PIN is entered.

**Note:** Rating standards differ by country.

## Enabling parental control of TV programs

This setting is provided separately to make it easier for you to unblock all blocked programming without disturbing the individual rating settings that you have set. For example, your kids are going to summer camp for two weeks and while they are gone, you don't want to have to deal with unblocking programs that you want to watch. All you need to do is clear **Enable parental controls**, and all TV programs are unblocked. When the kids return, select **Enable parental controls** again, and all of your parental control settings are restored in a single operation.

To enable parental control of TV programs:

1. From the Home Screen Menu, navigate to **Settings > Parental controls**, and then enter your parental control PIN.
2. In the **Parental controls** screen, navigate to **TV tuner > Enable parental controls**.
3. Make sure the **Enable parental controls** check box is selected. If not, highlight it and press **OK**.

To disable parental control of TV programs, repeat these steps, but highlight the **Enable parental controls** check box and press **OK** to clear it.

## Blocking based on US TV ratings

Most broadcast US TV programs—other than movies—contain rating data that enables parental controls to block programs that parents don't want others to view. The ratings are divided into two groups that function independently:

- **Youth group** – TV-Y, TV-Y7
- **Main group** – TV-G, TV-PG, TV-14, TV-MA

Within each of these groups, the ratings interact such that if you block a particular level of content, the TV also blocks all content with a higher rating. Conversely, if you unblock a particular level of content, the TV also unblocks all content with a lower rating. For example, if you block TV-PG programs, the TV also blocks TV-14 and TV-MA programs. If you subsequently unblock TV-14 programs, TV-PG programs are also unblocked, but TV-MA programs remain blocked.

Similarly, within the main group, content types can be individually blocked. For example, you can block just coarse language in programs with a TV-PG rating. If you do, then the TV also blocks programs with coarse language in the higher ratings (TV-14 and TV-MA). Subsequently unblocking coarse language in TV-14 ratings does not unblock coarse language in TV-MA programs, but it does unblock coarse language in TV-PG programs.

To block TV programs based on US television ratings:

1. From the Home Screen Menu, navigate to **Settings > Parental controls**, and then enter your parental control PIN.
2. Make sure the check box next to **Enable parental controls** is checked. If not, highlight it and press **OK**.
3. In the **Parental controls** screen, navigate to **TV tuner > TV ratings**. Choose among the following settings:
  - **Entire ratings** – Highlight the rating you want to block, and then navigate to the right and select the first option that blocks the entire rating level (and all higher rating levels).
  - **Individual content types** – Highlight the rating that contains the content type you want to block, and then select the content types you want to block from among those listed. Remember that blocking a content type in one rating blocks the equivalent content type in all higher rating levels.

## Blocking based on US movie ratings

Most movies in the US are rated by the Motion Picture Association of America, or MPAA, so the ratings are known as MPAA ratings. TV broadcast signals carry movie rating data that enables parental controls to block programs that parents don't want others to see. The ratings are:

- G – General audiences
- PG – Parental guidance suggested
- PG-13 – Parents strongly cautioned for children age 13 or younger
- R – Restricted
- NC-17 – Not for age 17 or younger

Unlike US TV ratings, there are no individual content types within the ratings. But like TV ratings, blocking movies with a particular rating also blocks movies with a higher rating, and unblocking movies with a particular rating also unblocks movies with a lower rating.

**Tip:** Blocking movies with an NC-17 rating also blocks programs with the now-obsolete X rating, which can still occur in the program data of older movies.

To block movies based on MPAA ratings:

1. From the Home Screen Menu, navigate to **Settings > Parental controls**, and then enter your parental control PIN.
2. Make sure the check box next to **Enable parental controls** is checked. If not, highlight it and press **OK**.
3. In the **Parental controls** screen, navigate to **TV Tuner > Movie ratings**.
4. Select the rating level you want to block. You need only select one rating level, and all higher levels are automatically blocked.

## Blocking based on Other ratings

Your TV can block programs having ratings that had not been defined when the TV was manufactured. It does this by detecting a new Rating Region Table in a program and then downloading the new table and displaying its rating in the Parental controls.

When the TV downloads a new Rating Region Table, it adds a new option to the list of rating types: **Other ratings**. If you see this option in the **Parental controls** screen, you have tuned to a station that has implemented a new rating table. Once the new rating table has been downloaded to the TV, it remains in the TV until it is factory reset, and you can configure blocking based on the new ratings.

New Region Rating Tables can have independent rating levels, or rating levels that interact in the same ways as the built-in US TV and MPAA Movie ratings.

**Tip:** If your TV downloads a new Region Rating Table, you'll have to experiment with its settings to understand how to use it.

## Blocking based on Canadian English ratings

Canadian-English language and third-language programs that are broadcast in Canada are rated by the Action Group on Violence on Television, or AGVOT. TV broadcast signals carry rating data that enables parental controls to block programs that parents don't want others to view based on content containing violence, language, sex, or nudity. The ratings are:

- C - Children under 8 years
- C8 - Children 8 years and older
- G - Generally suitable for all age groups
- PG - Parental guidance suggested for viewers under 14 years
- 14+ - Generally not suitable for viewers under 14 years
- 18+ - Generally not suitable for viewers under 18 years

Blocking content with a particular rating also blocks content with a higher rating, and unblocking content with a particular rating also unblocks movies with a lower rating.

To block programs based on AGVOT ratings:

1. From the Home Screen Menu, navigate to **Settings > Parental controls**, and then enter your parental control PIN.
2. Make sure the check box next to **Enable parental controls** is checked. If not, highlight it and press **OK**.
3. In the **Parental controls** screen, navigate to **TV tuner > Canadian English ratings**.

4. Select the rating level you want to block. You need only select one rating level, and all higher levels are automatically blocked.

## Blocking based on Canadian French ratings

Canadian-French language programs that are broadcast in Canada are rated by Québec's Ministry of Culture and Communications. TV broadcast signals carry rating data that enables parental controls to block programs that parents don't want others to view based on content containing violence, language, sex, or nudity. The ratings are:

- G - Generally suitable for all age groups
- 8+ - Viewers 8 years and older
- 13+ - Viewers 13 years and older
- 16+ - Viewers 16 years and older
- 18+ - Adults only

Blocking content with a particular rating also blocks content with a higher rating, and unblocking content with a particular rating also unblocks movies with a lower rating.

To block programs based on Canadian-French ratings:

1. From the Home Screen Menu, navigate to **Settings > Parental controls**, and then enter your parental control PIN.
2. Make sure the check box next to **Enable parental controls** is checked. If not, highlight it and press **OK**.
3. In the **Parental controls** screen, navigate to **TV tuner > Canadian French ratings**.
4. Select the rating level you want to block. You need only select one rating level, and all higher levels are automatically blocked.

## Blocking unrated programs

Some broadcast TV programs and movies do not have an assigned rating, and are considered to be “Unrated”. Whether or not such programs contain content that is objectionable to you cannot be determined. However, you can choose to block such programs.

To block all unrated broadcasts:

1. From the Home Screen Menu, navigate to **Settings > Parental controls**, and then enter your parental control PIN.
2. Make sure the check box next to **Enable parental controls** is checked. If not, highlight it and press **OK**.
3. In the **Parental controls** screen, navigate to **TV tuner > Block all unrated programs**.
4. Highlight **Block all Unrated programs** and press **OK**. When blocking is enabled, the adjacent padlock icon changes from unlocked to locked.

**Tip:** Blocking programs that have not been assigned a rating does not block programs that specifically have been assigned a US TV rating of “None” (for example a broadcast of a local town council meeting). Programs that do not have an assigned rating display *Rating NA* (for “not applicable”) meaning a rating is not needed).

In the absence of other ratings for a program, the parental controls do not consider the MPAA US movie rating *N/A* (MPAA rating not applicable to this content) and *NR* (applicable content not rated by the MPAA) to be ratings. In these cases, the TV handles the program as though it is unrated, blocking the program if *Unrated programs* blocking is enabled.



# What happens when a TV program is blocked?

After you've set up parental controls, TV programs and movies are blocked:

- When you change channels and the new channel is playing a program whose rating exceeds your settings.
- When a new program comes on the channel you are watching and its rating exceeds your settings.

When a program is blocked by parental control settings, the TV displays a blocked message:

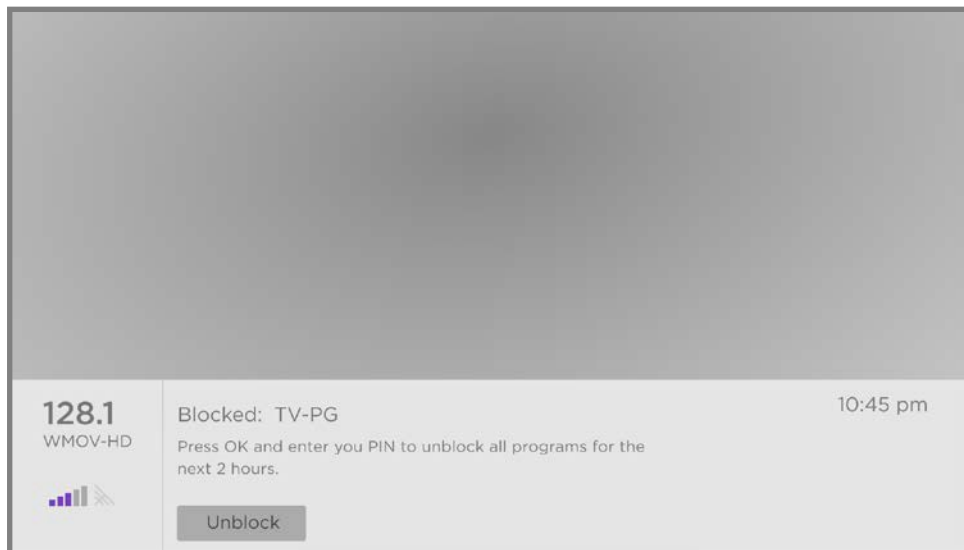

Whenever this blocked message appears, both the video and audio of the program are blocked, as well as program data that would normally appear in the area at the bottom of the screen.

To watch the blocked program, you need to know the PIN code defined when you enabled parental controls, as explained in [Creating a parental control PIN](#).

1. Press **OK** to select **Unblock**. The Parental Control PIN pad appears.

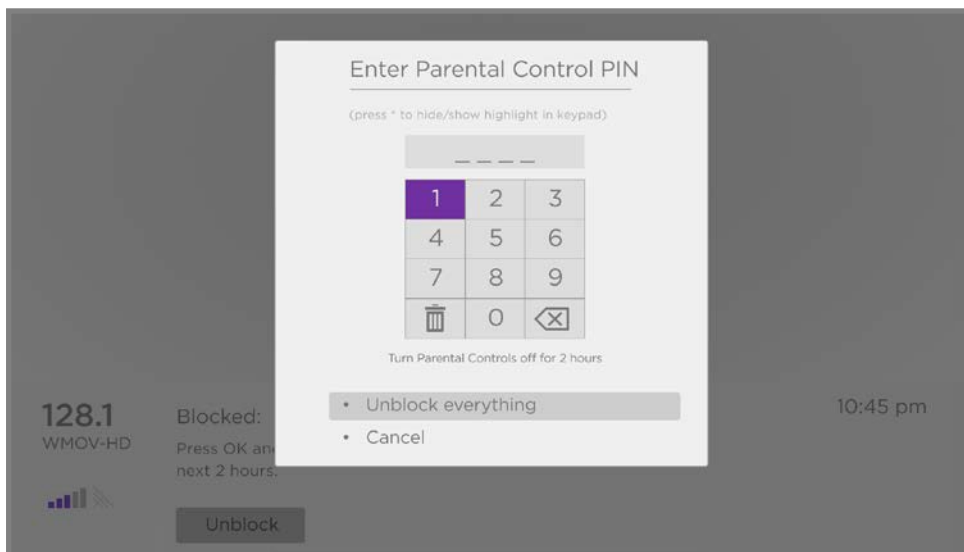

2. Use the purple directional pad to enter your parental control PIN code, and then press **OK** to select **Unblock everything**.

**Tip:** To shield your parental control PIN from others in the room, press **STAR \*** to hide the highlighted numbers. When you hide the highlight, you will have to count key presses to keep track of which number is selected.

After unblocking programs that have been blocked, all blocking is disabled for two hours or until you turn off the TV.

## Changing your PIN

1. From the Home Screen Menu, navigate to **Settings > Parental controls**, and then enter your parental control PIN.
2. In the **Parental controls** screen, highlight **Change PIN**.
3. Move the highlight into the on-screen keypad. Use the purple directional pad to enter a four-digit code, and then press **OK**. Then repeat the process to enter the same PIN again to make sure you correctly entered the PIN you want to use.

## Resetting parental controls

1. From the Home Screen Menu, navigate to **Settings > Parental controls**, and then enter your parental control PIN.
2. In the **Parental controls** screen, highlight **Reset parental controls**.
3. Follow the instructions on the screen to confirm that you want to erase all parental control settings.

**Tip:** Resetting parental controls also erases your parental control PIN.

# More settings

This section describes the features and settings of the TV that were not covered in the other parts of this guide.

## Guest Mode

When you enable Guest Mode, your guests can sign in to subscription channels using their own account credentials instead of using yours. Your guests' credentials are then automatically removed on the date they specify.

By enabling Guest Mode, your guests won't have access to your personal streaming channel accounts and won't be able use your Roku account to make purchases. Instead, your guests can safely access their own subscription channels. And they won't have to remember to sign out before they leave.

To enable Guest Mode:

1. From the Home Screen Menu, navigate to **Settings > Guest Mode**.
2. Select **Enter Guest Mode**.
3. Use the purple directional pad to enter your Roku Account PIN in the on-screen keypad.
4. Select **OK** to confirm and put the TV into Guest Mode.

**Note:** You also can enable and disable Guest Mode remotely by logging in to [my.roku.com](https://my.roku.com) on your computer or smart phone, scrolling down to *My linked devices*, and then selecting *Enable Guest Mode* or *Disable Guest Mode*, respectively.

After you put your TV into Guest Mode, it is ready to welcome your guests, allowing them to select a sign-out date. On the Home screen, they will find an assortment of default subscription channels. They can enjoy free content from The Roku Channel and many others, or sign-in and watch movies and TV programs from their own subscriptions and saved content libraries. Your guests can select **Streaming Channels**

from the Home Screen Menu to access the Roku Store to find and add channels they watch at home with confidence that their selections and usage history will be removed automatically on their sign-out date.

For more information about the experience your guests will have when Guest Mode is enabled, see the Roku support article [How to turn Guest Mode on and off on your Roku® streaming device](#).

To disable Guest Mode:

1. Press **HOME**  to return to the Home Screen Menu.
2. Navigate to **Settings > Guest Mode**.
3. Select **Exit Guest Mode**.
4. Enter your Roku Account PIN in the on-screen keypad.
5. Select **OK** and confirm that you want to disable Guest Mode.

After you disable Guest Mode, all of your original settings are restored and your channels are reinstalled. You might need to sign in to some of your subscription channels again to access your content.

**Note:** Any game data that was stored on your TV is not restored.

# Network settings

If needed, you can change your network settings at any time. For example, if you change the name of your wireless network (its SSID) or its password, you will need to change your TV's settings so that it can continue to connect.

To change network settings, from the Home Screen Menu, navigate to **Settings > Network**, and then press **RIGHT**. At this point, you can choose from among the following options:

- **About** – Lists important information about your current network connection, such as status, connection type, IP addresses, and MAC address. This information is often useful when contacting customer support with connection issues.
- **Check connection** – Select your existing network connection type, and then press **OK** to start checking the network connection. The TV uses your current network information to reconfirm the wireless or wired network connection to the local network and the Internet connection.
- **Set up connection** – Select a network connection type, and then select the option to set up a new connection. Follow the on-screen instructions to complete the network connection. For help with each of the steps, see [Network connection](#).
- **Bandwidth saver** – Enable or disable this feature as appropriate. If **On**, your TV prompts you to stop streaming if you haven't used the remote control within the past four hours. If you do not respond, streaming stops to save your data allocation and increase the network bandwidth available to other devices in your home. Change to **Off** to disable the automatic bandwidth saving feature.

**Note:** Some networks, such as those found in dorm rooms, hotels, and other public places, may require you to read and agree to terms, enter a code, or provide identifying information before letting you connect to the Internet. For more information, see [Using your TV in a hotel or dorm room](#).

## ZIP Code

Your TV needs to know your ZIP Code so that it can display the correct channels and program guide information. It attempts to determine your location by using information from your Internet connection; however, the information available from this source is not always accurate. To ensure you have the most accurate program guide information, use the **ZIP Code** option to enter your correct code.

To set your correct ZIP Code, from the Home Screen Menu, navigate to **Settings > System > ZIP Code**, and then press **RIGHT**. Enter your ZIP Code in the on-screen keypad, and then select **OK**.

## Time settings

You can change time settings to suit your preferences. You can find the following settings by navigating from the Home Screen Menu to **Settings > System > Time**:

- **Sleep timer** – Set a time delay after which the TV will automatically shut off. This setting reflects the setting you can make in the **TV settings** menu from any TV input, as explained in [TV settings menu](#).  
**Tip:** The sleep timer setting is not input specific, and also can be set by using the *Sleep timer* shortcut on the Home screen.
- **Time zone** – Your TV needs correct time zone information to correctly display program data. Choose whether to set the time zone automatically or manually, and if set manually, select your current time zone. Usually the TV can discover its own time zone automatically, but sometimes it cannot and must be set manually. Initially, this setting is made when you set up the TV tuner, as explained in [Setting up live TV](#).
- **Clock format** – Choose whether to display time in a 12-hour or 24-hour format, or to turn off time display.

## Scan again for live TV channels

There will be times when you need to create a new channel list. For example, you:

- Change cable providers
- Reorient your TV antenna
- Move to a different city with different channels

Whenever you need to update your TV channel list, you can repeat the channel scan.

**Tip:** Even if you don't change anything related to your TV channel reception, you should repeat the channel scan from time to time to make sure you are receiving all of the latest channels. Broadcasters add and remove channels, move channels to different parts of the spectrum, and change the power levels of their channels periodically.

**Note:** Repeating the tuner channel scan unhides all hidden channels.

To repeat the channel scan, highlight the **Live TV** input on the Home screen, and then press **STAR \***. Next, select **Scan for channels** and press **OK**. After that, the screens and options that appear during this process are identical to those described in [How do I set up the TV tuner?](#)



- **Standard** – Configure the input for compatibility with HDMI® version 2.0, which supports a maximum refresh rate of 60 Hz at full UHD resolution. You must use this mode to view HDR content from the device connected to this **HDMI** input. However, note that many older HDMI® devices do not work correctly when the TV's HDMI input is set to this mode. After enabling this setting, you can optionally turn **Auto low latency mode** (ALLM) off or on.
- **Compatibility** – Configure the input for compatibility with HDMI® version 1.4, which supports a maximum refresh rate of 30 Hz at full UHD resolution. Most HDMI® devices will work correctly with the TV in this mode.

## Control by mobile apps

You can choose the level of control you want to allow your TV to accept from external devices, such as smart phones, tablets, and virtual assistants. Device connect settings enable other devices, including the Roku mobile app, to control your TV over the local area network in your home.

To adjust the level of external control access:

1. From the Home Screen Menu, navigate to **Settings > System > Advanced system settings > Control by mobile apps**.
2. Select **Network access**.
3. Select one of the following settings:
  - **Default** – Devices can connect only through a private network address, and accept commands only from other private network addresses on your home network. This setting is suitable for most cases, including use of the Roku mobile app on your smartphone.
  - **Permissive** – Devices can connect under all conditions, but accept commands only from private network addresses or the same subnetwork within your home network. This setting might be required when attempting to operate the TV from a third-party application, for example, one of the Internet of Things (IoT) applications such as ifttt.com.
  - **Disabled** – Device connection is completely disabled. The TV does not accept external commands from any source, including the Roku mobile app.

# Changing privacy settings

## Advertising

By default, your TV uses an advertising identifier to track your TV usage. You can change the privacy settings on your TV in two ways: resetting the advertising identifier and disabling personalized ads.

To learn more about these options, please see Roku's Privacy Policy at [go.roku.com/PrivacyPolicy](https://go.roku.com/PrivacyPolicy).

### Reset the advertising identifier

Resetting the advertising identifier clears the prior usage history that your TV stores, and then begins tracking again. From that point forward, your new usage patterns affect the advertisements you see on your TV.

1. From the Home Screen Menu, navigate to **Settings > Privacy > Advertising**.
2. Highlight **Reset advertising identifier**. Press **STAR \*** to view more information about this option. When you finish reading the information, press **OK** to close the More Information window.
3. Press **OK** to reset the advertising identifier, and then press **OK** again to dismiss the verification message.

### Personalized ads

You can limit Roku's tracking of your usage behavior by turning off personalized ads. When you do, your TV will display ads that are not personalized based on your TV's advertising identifier.

1. From the Home Screen Menu, navigate to **Settings > Privacy > Advertising**.
2. Highlight **Personalized ads**. Press **STAR \*** to view more information about this option. When you finish reading the information, close the **Personalized ads** window.
3. Press **OK** to clear the **Personalized ads** check box.

**Note:** If you perform a factory reset, personalized ads are reenabled until you repeat these steps.

## Voice

Select Voice to change settings related to using your voice to interact with the TV.

### Microphone access

Your Roku TV does not have a built-in microphone. However streaming channel providers can use the microphone on Roku Voice remotes (certain models) or on your mobile device when the Roku mobile app is running. You can control whether streaming channels have permission to use the microphone.

**Note:** These settings affect only streaming channel access to the microphone. They do not affect your Roku TV's Voice Search feature.

#### Channel microphone access

You can control which streaming channels have permission to use the microphone, giving you control over how the microphone is used by each streaming channel. The default setting is **Prompt**, so channels will not be able to turn on the microphone without your permission.

To change microphone access settings:

1. From the Home Screen Menu, navigate to **Settings > Privacy > Voice > Microphone access**.
2. Select **Channel microphone access**.
3. Choose one of the following settings:
  - **Prompt** – Display a notification the first time a streaming channel requests the use of the microphone. When such a notification appears, you can select either **Allow microphone access** or **Deny microphone access** on a per-channel basis. If you choose to allow microphone access, you'll be prompted to confirm your choice by entering a numeric code that appears on the screen.
  - **Always allow** – Do not prompt, but always allow any streaming channel to use the microphone.
  - **Never allow** – Do not prompt, but never allow any streaming channel to use the microphone.

## Channel permissions

After granting or denying microphone access on a per-channel basis, you can reset channel permissions to enable them to once again follow the system-wide setting you specify under [Channel microphone access](#).

To reset channel permissions:

1. From the Home Screen Menu, navigate to **Settings > Privacy > Voice > Microphone access**.
2. Select **Channel permissions**.
3. Highlight **Reset channel permissions**, or highlight a specific listed channel, and then press **OK** to deny microphone access to all or to a specific channel.

## Speech recognition

By default, Roku uses recordings of your voice interactions with Roku Voice Remotes and the Roku mobile app to improve its speech recognition abilities. If you do not want to allow Roku to use your voice for this purpose, from the Home Screen Menu, navigate to **Settings > Privacy > Voice** and clear the **Speech recognition** check box.

## Smart TV experience

Your TV prompts you to [opt in to the Smart TV experience](#) when you first start watching TV programs. Regardless of your decision at that time, you can change your decision later.

To change your Smart TV experience choices:

1. From the Home Screen Menu, navigate to **Settings > Privacy > Smart TV experience**.
2. Highlight the setting you want to change, and then press **OK** to enable or disable it.
  - **Use info from TV inputs** - Authorizes Roku to collect and share information about what, when, and how you are watching and use this to make recommendations.

- **Enable auto notifications** – Displays brief notifications from the Smart TV experience across the bottom of the screen when recommendations are available.

**Note:** These settings do not affect recommendations for More Ways to Watch that you see in the Live TV Channel Guide when watching live TV channels. Press **STAR \*** while each of these settings is highlighted to view more details about how Roku collects and uses this data.

## Roku TV soundbars and wireless speakers

Your Roku TV works with several Roku premium audio products, including the Roku Streambar®, Roku Streambar Pro, Roku TV Wireless Soundbar, Roku wireless speakers, Roku Wireless Bass, and Roku Wireless Bass Pro. Certain TV models also support pairing multiple wireless speakers in various configurations to provide wireless surround sound without the use of a sound bar or home theater receiver.

With Roku TV premium audio products, you can listen to all of your TV programs as well as the sound from any streaming channel. After you have paired your speakers with your Roku TV, all sound normally comes from the paired speakers instead of the internal TV speakers, unless you change the default setting in **Settings > Audio > Audio output**.

If you have connected a Roku Streambar® to your Roku TV, you can put away the soundbar remote control and use the TV's **Sound settings** menu to control sound options while watching a program. See [Roku premium audio products](#) for details.

## Roku wireless speakers

TV models that support wireless surround sound can function with left and right front speakers in a 2.0 configuration or both right and left front and rear speakers in a 4.0 configuration. Add a Roku Wireless Subwoofer to create a 2.1 or 4.1 surround configuration.

**Note:** Certain TVs support Dolby Atmos<sup>®</sup> audio technology. However, wireless surround speaker configurations do not support Atmos. When you are playing Atmos content from a TV that supports Atmos through wireless surround speakers, the TV instead applies Dolby Digital sound technology.

### Setting up Roku wireless speakers

To begin pairing a set of wireless speakers:

1. Make sure the speakers are plugged in and your TV is turned on.
2. Hold down **HOME**  on your TV remote for five seconds until the **Select all devices to set up** screen appears.
3. Select the appropriate item to set up: **Wireless speakers**, **Wireless soundbar**, or **Subwoofer**.
4. Select **Continue**, and then follow the instructions on the screen to complete the pairing process.

For more information, including details about how best to arrange your speakers in your room, see the Roku support article [How to set up your Roku wireless speakers](#).

### Checking Roku Soundbar or Roku Speaker software version

If you are having issues with your Roku audio devices, your Roku support technician might ask you to provide the software version of a particular device.

To determine the software version of a Roku audio device that is connected to or paired with your TV:

1. From the Home Screen Menu, navigate to **Settings > Remotes & devices**.
2. Select **Speakers**.

3. Select the device whose software version you want to view from among your connected devices: **Wireless speaker**, **Wireless soundbar**, **Streambar**, **Streambar Pro**, or **Subwoofer**.
4. Select **About**. On this screen, you can find information about the device, including the **Software version**.
5. Repeat steps 3 and 4 to view the software version for additional Roku audio devices.

## Factory resetting a Roku soundbar or Roku speakers from the TV

If needed, you can factory reset your soundbar or speakers directly from your TV. You'll need to factory reset them if you want to pair them with another Roku device, or if you want to correct the speaker channel (left, right, front, or rear) assignments. You also can factory reset your Roku Streambar if you want to transfer it to another person. Factory resetting removes all of your channels, settings, subscriptions, and personal information from the device.

To factory reset a connected Roku audio product:

1. From the Home Screen Menu, navigate to **Settings > Remotes & devices**.
2. Select **Speakers**.
3. Select the device to reset from among your connected devices: **Wireless speaker**, **Wireless soundbar**, **Streambar**, **Streambar Pro**, or **Subwoofer**.
4. Select **Factory reset** and then use the on-screen keypad to enter the code displayed on the screen to confirm.
5. Repeat steps 3 and 4 to factory reset additional Roku audio devices.

For more information about resetting Roku audio devices, see the Roku support article [How to factory reset your Roku wireless audio device](#).

# Home theater configuration

Your TV has several features that make it an ideal TV for a home theater. But you might not notice them because they remain in the background until you decide to use them.

## Controlling audio output

You can control how your TV outputs sound by navigating to **Settings > Audio > Audio output**. Choose from the following options:

- **Auto** – Let the TV decide the best way to output audio, automatically selecting the S/PDIF optical port, HDMI® ARC/eARC port, Roku wireless speakers (certain TV models), or the built-in TV speakers.
- **ARC (HDMI *n*)** – Always output audio to the indicated HDMI® ARC or eARC port (depending on model). Turn off the built-in TV speakers. The audio return channel (ARC) enables the TV to send Dolby Audio™ or DTS audio content back to a home theater receiver or Roku Streambar® that is also sending an audio and video signal into the TV. Using HDMI® ARC or eARC reduces the number of cables needed and controls the volume and mute state of the receiver while watching TV.
- **TV speakers** – Always output audio to the built-in TV speakers.
- **Optical** – Always output audio to the S/PDIF optical port. Turn off the built-in TV speakers.

Regardless of which setting you choose, your TV automatically mutes the active audio output when you do any of the following:

- Plug headphones into the headphone jack on the TV.
- Plug headphones into a Roku remote that supports wireless private listening.
- Turn on wireless private listening in the Roku mobile app.
- Only on certain models, connect a Bluetooth headphone or speaker to the TV.



## Wall-mounted TV

Only on certain models, you can optimize the sound from the TV speakers when your TV is mounted on a wall. To do so, from the Home Screen Menu, navigate to **Settings > Audio > Wall-mounted TV** and toggle the setting **On**.

## Setting up a digital audio connection

To take advantage of your TV's advanced audio capabilities, connect it to an external amplifier, receiver, or soundbar by using either of these two digital audio connections:

- **HDMI ARC or HDMI eARC** – The HDMI® Audio Return Channel (ARC) or on certain TVs only, the HDMI® Enhanced ARC (eARC) connector enables the TV to output digital audio on one of its HDMI® connectors. The connected amplifier then can function simultaneously as an input source to the TV, if needed, without the need to use additional cables.



To use the ARC or eARC capability, you must connect an HDMI® cable from your amplifier's HDMI® ARC or eARC connector to the **HDMI ARC** or **HDMI eARC** connector on the TV. You also must do the following:

- Be sure your HDMI® cable is HDMI® certified.
- Select **Auto** or **ARC** under **Settings > Audio > Audio output**.
- **S/PDIF optical** – The S/PDIF optical connector outputs a digital audio signal. To use the optical output, connect a TOSLINK optical cable from the amplifier to the Optical or S/PDIF connector on the TV.



**Important:** To make sure the S/PDIF outputs audio reliably, you must turn off the TV's speakers. To do so, from the Home Screen Menu, navigate to **Settings > Audio > Audio output** and change the setting to **Optical**.

**Note:** Dolby Audio™ support for Dolby Digital Plus™ format is not available through the S/ PDIF optical output. This format is only available through the **HDMI ARC** connection.

**Tip:** When you use S/PDIF for audio, the TV can correctly detect more audio formats if you also connect an HDMI® cable between the TV's **HDMI ARC** or **HDMI eARC** port and the receiver's ARC or eARC port.

## Choosing a preferred audio streaming format

Some streaming content is available with multiple audio formats. You can choose the format you prefer from among the following options:

- **Auto** – Automatically selects the best audio format for the content you are streaming.
- **Dolby** – Selects Dolby Audio if it is available. Otherwise, selects the best available format.
- **DTS** – Selects DTS if it is available. Otherwise, selects the best available format.

## Choosing an audio digital output format

After making the required HDMI® ARC, eARC, or S/PDIF optical connection, from the Home Screen Menu, go to **Settings > Audio > Digital output format** and select the audio format to use.

Choosing **Auto** is the easy solution, and generally provides good results. However, if you have a high-end sound system and want to make sure you are getting the best sound quality available in the programs you are watching, you can choose another setting.

- **Auto** – Automatically detects the incoming audio format and transcodes it to a compatible available format for the audio output (ARC, eARC, or S/PDIF).
- **Passthrough** – Passes through the input audio to the connected receiver without transcoding, sometimes resulting in better audio quality especially for high-end audio formats such as those that take advantage of the higher bandwidth of eARC, including Dolby MAT and Dolby Digital Plus 7.1, among others.
- **Stereo** – Always outputs stereo, regardless of input audio format.

- **Custom** – When selected, reveals the following additional options for Dolby and DTS audio:
  - **Dolby** – Converts all input formats to either Dolby Digital or Dolby Digital Plus, according to the option you choose:
    - **Dolby Digital** – Converts all input formats to Dolby Digital.
    - **Dolby Digital Plus** – Converts all input formats to Dolby Digital Plus.
  - **DTS** – If you select **On**, converts all audio sources except DTS to Dolby Digital or Dolby Digital Plus according to the Dolby option you selected. If DTS is detected and the receiver supports DTS, this option passes through the DTS audio without modification. If you select **Off**, the TV does not detect or pass through DTS audio.

**Note:** DTS audio formats are meant to be used with ARC, eARC, or S/PDIF connections to a DTS-capable home theater receiver. If you enable DTS when using the TV speakers, you might not hear any audio.

## Dolby Atmos notification

Only on models that support Dolby Atmos<sup>®</sup> audio technology, you can enable or disable the on-screen notification that appears when you start watching content that contains Atmos audio.

To disable the notification, from the Home Screen Menu, navigate to **Settings > Audio > Dolby Atmos** notification, and toggle the setting **Off**.

## Adjusting audio delay

Soundbars, receivers, and other custom audio setups can introduce delays that cause the sound to be out of sync with the picture. To correct this issue, you can use a feature of the Roku mobile app to analyze the delay through your smart phone camera and microphone.

In the Roku mobile app<sup>1</sup> Remote screen, touch **Settings**, and then select **Adjust audio delay**. Follow the instructions on the screen to complete the audio delay adjustment. Your Roku TV stores the delay values and uses them whenever you play content through the connected audio device.

---

<sup>1</sup> Requires Roku mobile app version 8.7.0 or higher.

## Turning off the TV screen while listening to music

While listening to music or other audio-only content on your TV, you might want to turn off the TV screen.

To turn off the TV screen:

1. Press **STAR \*** to display the **TV settings** menu.
2. Press **DOWN** to highlight **Turn off display**.
3. Press **OK**.

**Tip:** If you are using a Roku Voice Remote or the Roku mobile app, press **VOICE**  and say, “Turn off the display.”

**Note:** This feature may not be available on all streaming channels, and is available only when **Fast TV Start** is enabled. To enable **Fast TV Start**, from the Home Screen Menu, navigate to **Settings > System > Power**.

## Controlling other devices through CEC

Consumer Electronics Control (CEC) enables your TV and other CEC-compatible home entertainment devices to control one another in various ways. First, the CEC-compatible devices must “discover” one another and report their capabilities. After this, one device can control another according to the features you enable. For example, playing a disc on a Blu-ray™ player could switch the TV to the Blu-ray™ player’s input. Or, powering off the TV could also power off the Blu-ray™ player and the home theater receiver.

### Discover connected CEC devices

To discover CEC devices:

1. Make sure that your CEC-compatible devices are connected to the TV with a suitable certified HDMI® Cable that supports HDMI® ARC and CEC control.
2. Turn on each device and make sure all devices are CEC enabled.

**Tip:** Some manufacturers have their own branded names for CEC functionality, so you might need to read the product documentation to correctly identify the CEC features of the device.

3. On the TV's Home Screen Menu, navigate to **Settings > System > Control other devices (CEC)** and then select **Search for CEC devices**. Press **OK** to repeat the discovery process, if necessary.

When finished, the TV displays a list of CEC devices that are connected to each **HDMI** input, as well as any devices that had previously been connected. The TV remembers the names of multiple CEC devices even when they are no longer connected. If the list is longer than the allowed space, press **STAR \*** to see a complete list in a scrollable window.

### Enable 1-touch play

1-touch play enables a device to control which TV input is active. For example, pressing **Play** on your Blu-ray™ player switches the TV to the Blu-ray™ input.

1-touch play is disabled by default. To enable 1-touch play, from the Home Screen Menu, navigate to **Settings > System > Control other devices (CEC)** and highlight **1-touch play**. Press **OK** to enable or disable the feature.

### Enable system standby

The system standby feature causes other devices to power off when you power off your TV. Depending on the CEC System Standby implementation, it also might enable connected devices to power off your TV when you power off the device.

System standby is disabled by default. To enable system standby, from the Home Screen Menu, navigate to **Settings > System > Control other devices (CEC)** and highlight **System standby**. Press **OK** to enable or disable the feature.

## Restart the TV

You can restart the TV when necessary. Restarting has the same effect as unplugging the TV power and then plugging it in again.

To restart the TV, navigate to **Settings > System > Power**, and then select **System restart**. Highlight **Restart**, and then press **OK** to confirm restart.

While the TV restarts, the screen goes dark for a few seconds, and then displays the startup screen for a few more seconds. When the restart operation completes, the TV displays the activity you selected in [Power on settings](#).

# Reset the TV

You can choose to reset only the TV picture and audio settings to their original values, or perform a full factory reset to return the TV to the state it was in when you first unpacked and turned it on.

## Reset audio/picture settings

To reset only the TV picture and audio settings to their original values, navigate to **Settings > System > Advanced system settings > Factory reset**, and then highlight **Reset TV audio/picture settings**. Read the information on the screen to make sure you understand what the reset operation does.

To proceed with the reset operation, press **PLAY/PAUSE ►||** three times in a row.

## Factory reset everything

A full factory reset returns the TV's settings to their original state and removes all personally identifiable information from the TV. When finished, you must repeat Guided Setup, reconnecting to the Internet, re-linking your Roku account, and reloading any streaming channels. You also must repeat live TV setup and input configuration.

Factory reset is the recommended choice if you want to transfer the TV to another owner, and it is the only choice if you want to switch from Store mode to Home mode (if you inadvertently selected Store mode during Guided Setup). Before performing a factory reset, we recommend you read this Roku support article to diagnose your issue and determine if there are other ways to solve the problem: [How to system restart or factory reset your Roku streaming device](#).

To perform a factory reset, navigate to **Settings > System > Advanced system settings > Factory reset**, and then highlight **Factory reset everything**. Read the information on the screen to make sure you understand what this reset operation does.

To proceed with the full factory reset, use the on-screen number pad to enter the code displayed on the screen, and then select **OK** to proceed.

When the factory reset operation completes, the TV restarts and displays the first [Guided Setup](#) screen.

## What if I can't access the Factory Reset option?

It is possible for your TV to get into a state where you cannot access the various menus, including the menu option that lets you perform a factory reset operation. If that happens, you can force the TV to reset by following these steps.

1. Using a straightened paper clip or ball-point pen, press and hold the recessed RESET button on the TV connector panel.
2. Continue to hold the RESET button for approximately 12 seconds.  
When the reset cycle completes, the status indicator comes on dim.
3. Release the RESET button. The TV is now powered off.
4. Turn on the TV and proceed through Guided Setup. See [Guided Setup](#).

## Using Recovery Mode

Certain models have another reset option called Recovery Mode, which you can access by holding down the RESET button for at least 20 seconds. For a list of models that support Recovery Mode and detailed instructions about how to use it, see the Roku support article [How to use Recovery Mode on your Roku TV™](#).

## Network connection reset

If you want to remove your network connection information without disturbing other settings, navigate from the Home Screen Menu to **Settings > System > Advanced system settings > Network connection reset**, and then select **Reset connection**.

When you select this option, the TV removes your wireless network information, including the name of the connection (its SSID) and your wireless password, if any, and then it restarts. After restarting, your TV retains all of its other settings including its association with your Roku account.

After resetting your network connection, navigate from the Home Screen Menu to **Settings > Network > Set up connection** to set up your network connection and enjoy all of the benefits of your connected TV.

# Roku Account PIN

When you created your Roku account, you were given the opportunity to create a PIN code and specify when it must be used. You can:

- Require that users enter the PIN to make purchases through the TV.
- Require that users enter the PIN to add items from the Roku Store.
- Establish parental controls for The Roku Channel.
- Enable or disable Guest Mode.

Follow these steps if you created a Roku PIN and want to change it, or you don't remember your PIN, or if you didn't create a Roku Account PIN and want to add one.

1. Use a web browser to go to <https://my.roku.com> and sign in.

After signing in, the **My account** page appears.

2. Under **PIN preference**, click **Update** to open the **Choose your PIN preferences** page.
3. Use the options on this page to create or change your Roku PIN and to specify how the PIN is to be used.
4. Click **Save Changes** to save your changes and return to the **My Account** page. Note that your current setting is described under **PIN preference**.

## Update the TV

Your TV automatically updates itself from time to time. You don't need to do anything. But if you are aware that an update is available and you don't want to wait until the TV updates itself, you can manually check for updates.

If you're one of those people who has to have the latest, most up-to-date features the moment they are available, you can check for updates as often as you want.

To check for updates, navigate to **Settings > System > Software update**, and then select **Check now**. The TV responds either with a message saying that your TV is up to date, or with a message saying that an update is available.

Follow the instructions on the screen to install the software update.



**Note:** Sometimes software updates install new system software, and other times they install new features for streaming channels. Therefore, you won't always see a change in the behavior of your TV after a software update.

**Tip:** You can download an updated User Guide for the latest software version from the Roku TV web site at:

[go.roku.com/tvmanual](https://go.roku.com/tvmanual)

# Using other devices with your TV

## Using Bluetooth® private listening (certain models)

Only on certain models, you can pair your Bluetooth headphones or earbuds and use them to listen privately to the TV. When Bluetooth headphones are connected, you can listen to any content playing on your TV, and the TV automatically mutes the sound from its speakers or other connected audio devices.

**Note:** You can also pair most Bluetooth speakers by following these instructions.

### Pair your Bluetooth headphones

Before you can listen to your TV through your Bluetooth headphones, you must pair them with the TV. You typically need to pair them only one time, after which they will appear in the list of paired devices.

To pair your headphones:

1. From the Home Screen Menu, navigate to **Settings > Remotes & devices**, and then select **Wireless headphones**. (If you do not see this option, your TV does not have the Bluetooth feature.)
2. Select **Add new wireless headphones** and press **OK**.
3. Turn on your Bluetooth headphones and using the manufacturer's instructions, put them in pairing mode.
4. Wait while your TV scans for Bluetooth headphones. Scanning might take up to 30 seconds.
5. Select your Bluetooth headphones from the list of available devices.

## Connect your Bluetooth headphones

When you are ready to listen to your TV through your Bluetooth headphones:

1. While playing a program on your TV, press **STAR \*** and then select **Wireless headphones**.

Alternatively, if you are not already playing a program, from the Home Screen Menu, navigate to **Settings > Remotes & devices**, and then select **Wireless headphones**.

2. Select your headphones from the list.
3. Select **Connect**.

**Notes:** When you connect your headphones, the TV mutes its speakers or other audio output devices (soundbar or home theater receiver) until you disconnect the headphones.

When your Bluetooth headphones are connected, you can adjust the volume and mute by using the buttons on your remote control or the buttons on the headphones themselves. When you do, notice that the volume icon in the upper right corner of the TV screen shows a headphone icon .

You can pair multiple Bluetooth headphones to your TV but only one set can be connected and used at a time. In the case of separate left and right wireless earbuds, the pair counts as a single device.

## Disconnect your Bluetooth headphones

When you want to restore audio output from the TV speakers or other audio devices, you must disconnect your headphones.

To disconnect your headphones, turn them off. Alternatively, you can repeat the steps you followed to connect them, and then select **Disconnect**.

## Disable Bluetooth auto detect

Most Bluetooth headphones when turned on try to connect to the most recent device. If auto-detect is turned off or your headphones do not automatically connect, you must use the previous instructions to manually connect your headphones when you want to use private listening.

To change the auto-detect setting:

1. From the Home Screen Menu, navigate to **Settings > Remotes & devices**, and then select **Wireless headphones**.
2. Select your headphones from the list.
3. Select **Auto detect** and select **Off** or **On** as desired.

## Pairing your phone, tablet, or computer with Bluetooth®

Only on certain TVs, you can pair your mobile phone, tablet, or computer via Bluetooth to play audio from that device through your TV. Use this feature to play your music library, podcasts, meeting audio, or any other sounds from your paired device.

Before you can connect your Bluetooth device to your TV, you must pair the device with the TV. You typically need to pair your device only one time, after which it will appear in the list of paired devices. If desired, you can pair multiple Bluetooth devices.

### Pair your device

To pair your Bluetooth phone, tablet, or computer:

1. Turn on your device and navigate to its Bluetooth settings.
2. From the Home Screen Menu on your TV, navigate to **Settings > Remotes & devices > Smartphones & tablets**, and then select **Add a new smartphone or tablet**. (If you do not see this option, your TV does not have the Bluetooth feature.)

3. Wait until your device discovers the TV and displays it in its list of available Bluetooth devices. As the pairing process progresses, your TV displays a **Searching** screen that shows the name to look for in your device's Bluetooth list.
4. Select your TV from the Bluetooth list on your device. Its name is listed according to the TV model you are pairing, as was shown in the Searching screen. Example, **Roku Plus Series 4K - 75"**.
5. A few moments after pairing, your device appears on the **Remotes & devices** screen. A check mark adjacent to your device's name indicates that it is connected.

**Note:** If no check mark appears next to the device's name, follow the steps in the next topic to connect.



For more information on using Bluetooth headphones for private listening, see the Roku support article [How to use Bluetooth headphones for private listening on your Roku streaming device.](#)

## Connect your device and play audio on your TV

When you are ready to play audio content from your Bluetooth device to your TV:

1. Turn on your TV and your device.
2. Navigate to your device's Bluetooth settings.
3. Select your Roku TV from the list of paired devices to connect

**Note:** Your device might automatically connect to your TV. If so, steps 2 and 3 are not necessary.

4. Play audio content from your device.
  - You can use either your device's controls or your TV remote to control volume and mute. You might find that the volume controls operate independently—that is, your device's volume does not control the TV volume, but affects the overall volume of the sound.
  - Depending on your device, you can use the **REWIND** , **FAST FWD** , and **PLAY/PAUSE**  buttons on your TV remote to control playback.

5. From the Home Screen Menu on your TV, navigate to **Settings > Remotes & devices > Smartphones & tablets**, and then select your device's name from the list of paired devices.

## Disconnect your device

If you do not want your device to automatically connect to your TV, you can disconnect it when you finish playing your audio content. Disconnected devices remain paired and can be reconnected quickly by following the steps in the previous topic.

You can disconnect your TV from your device by doing either of the following:

- On your device, navigate to the Bluetooth settings menu, select your Roku TV, and then select **Disconnect**.
- On your TV, navigate to **Settings > Remotes & devices > Smartphones & tablets**, select your device's name from the list of paired devices, and then select **Disconnect**.

For more information on using your phone, table, or computer to play audio via Bluetooth, see the Roku support article [How to turn on Bluetooth® pairing and connect your phone to your Roku® device](#).

## Mirroring your phone or tablet

Your TV has a feature called screen mirroring that lets you mirror your compatible smartphone or tablet on your TV. Share videos, photos, web pages, and more from compatible devices.

By default, your TV's screen mirroring mode is set to **Prompt**. In this mode, when your TV receives a screen mirroring request, it prompts you with the following options, unless you have previously selected **Always allow** or **Never allow** for the device:

- **Always allow** – Always accept mirrored content from the mobile device without additional prompting in the future for this device.
- **Allow** – Accept mirrored content from the mobile device this time only. Prompt again next time this device attempts to mirror content.

- **Block** – Do not accept mirrored content from the mobile device at this time. Prompt again next time this device attempts to mirror content.
- **Always block** – Never accept mirrored content from this mobile device.

**Note:** You can manage and change the list of devices that are set to *Always allow* or *Always block* by navigating from the Home Screen Menu to **Settings > System > Screen mirroring > Screen mirroring devices**.

- If you prefer to always allow all screen mirroring attempts without prompting, go to **Settings > System > Screen mirroring**, and then change the **Screen mirroring mode** to **Always allow**.
- If you prefer to never allow screen mirroring from any device, change the **Screen mirroring mode** to **Never allow**.

For information on which devices may work with screen mirroring and instructions on how to use it, go to the following link on the Roku web site:

[go.roku.com/screenmirroring](https://go.roku.com/screenmirroring)

## Roku mobile app

Roku makes the Roku mobile app free for compatible iOS® and Android™ mobile devices.

The Roku mobile app is an alternative control center for your Roku TV, plus a way to stream Roku content while you are on the go. The Roku mobile app helps you find and add new Roku Channels, more easily search and find something to watch and even use your voice to search without typing.

Find more information and get the Roku mobile app by using the following link to the Roku web site:

[go.roku.com/mobileapp](https://go.roku.com/mobileapp)

## Private Listening on the Roku mobile app

Only on compatible Apple and Android devices, the Roku mobile app enables you to use headphones connected to your device to listen to streaming programs and live digital TV channels. Make sure you have the latest version of the Roku mobile app before using this feature.

For more information, go to the following link on the Roku web site:

[go.roku.com/privatelistening](https://go.roku.com/privatelistening)

## Using a universal remote

In many cases, you can program your cable or satellite universal remote to also control your TV. You will need to have instructions for programming the remote handy. Check with your cable or satellite provider for instructions.

For details on how to set up the TV to work with universal remotes, go to the following link on the Roku web site:

[go.roku.com/universalremote](https://go.roku.com/universalremote)



# What if I didn't connect my TV?

**Note:** Some models cannot function without an Internet connection, and so this information might not apply to you.

What if you went through Guided Setup and chose **Connect to the Internet later**? No worries. Your Roku TV makes it easy to connect whenever you want. As you move around the Home screen, you'll see several places where you can start the connection process. For example:

- Now and then you'll see a message appear on the panel to the right of the Home screen offering a **Connect Now** option. You can highlight and select the **Connect Now** option to get started.
- Use the **Connect and activate now** option. From the Home Screen Menu, select **Settings**, then **Network**, and then **Connect and activate now**.
- If you want to start over from the beginning, do a **Factory reset**, and then go through Guided Setup again. This time, select your home network when prompted.

## What you're missing by not connecting

Many of your Roku TV's best features are available only when you connect it to the Internet and pair it with a free Roku account. Without connecting, your Home screen looks similar to the following:



Here is a list of what you are missing if you choose not to connect your TV:

- The Roku Channel
- The Roku Store and access to all streaming services
- Voice control and search features available through a Roku Voice Remote
- Google Home, Amazon Alexa, and Apple HomeKit/Apple Siri interactions
- Roku Search, including searching Live TV (over-the-air channels)
- Live streaming TV channels
- Live TV pause
- Live TV Channel Guide along with its channel categorization and channel filtering
- More Ways to Watch
- Smart TV Experience
- Featured Free
- My Offers
- Fast TV Start and features available only when it is enabled
- Guest mode
- Roku mobile app interactivity
- Bluetooth® private listening and Bluetooth phone/tablet/computer connectivity
- Roku Media Player, Media Player auto-launch, and DLNA/UPNP connectivity
- Picture off option
- Themes, theme packs, sounds, wallpapers, and screensavers

# Managing live TV channels when your TV is not connected

If you elected to not connect your TV to the Internet, the **TV settings** menu does not have a **Manage channels** option. Instead, you can designate favorite channels and edit your channel lineup as explained here.

## Designating favorite channels

Use the channel list to designate any number of channels as your favorites and to change from surfing among all channels or only your favorite channels.

1. While watching live TV, Press **LEFT** to display the channel list. Notice that the words **All channels** appear at the top of the channel list.
2. Scroll up or down to highlight a channel that you want to make a favorite.
3. Press **STAR \***, and then press **OK** to select **Add to favorites**. If the channel is already one of your favorites, press **OK** to select **Remove from favorites**. A **FAVORITE** symbol  appears next to each channel you designate as a favorite.

## Surfing only favorite channels

After you've marked one or more channels as favorites, you can switch to your favorite channels.

1. While watching live TV, press **LEFT** to display the channel list.
2. Press **LEFT** or **RIGHT** once to switch to **Favorites**. Notice that the word **Favorites** appears at the top of the channel list.
3. Highlight a channel and press **OK** to select a channel or wait a few moments until the channel list disappears.
4. Press **UP** or **DOWN** to change to the previous or next favorite channel. Channel surfing is limited to favorite channels only.

To see all of your channels again, repeat these steps, but this time select **All Channels**.

When you view the program information banner while watching a favorite channel, a **FAVORITE**  symbol appears next to the channel call sign.

## Editing the channel lineup

When you scan for channels described in [Setting up live TV](#), the TV adds all the channels with good signals that it can detect in your area. It is likely that you now have more channels than you want in your channel list.

To edit the channel lineup, from the Home Screen Menu, navigate to **Settings > TV inputs > Live TV** and then select **Edit channel lineup**. You'll see a screen listing all of your channels. Adjacent to the list of channels is a miniature TV screen playing the highlighted channel's picture and sound.

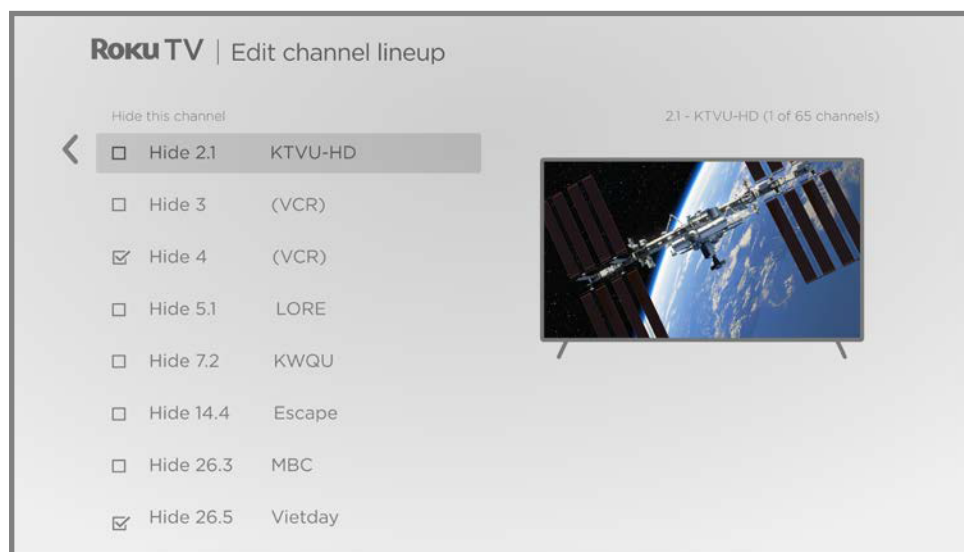

For each channel you want to hide, highlight it, and then press **OK** to select its check box.

**Tip:** If you need to view the highlighted channel to decide whether to hide it, wait a couple of seconds for the TV to start playing the channel's picture and sound. If you've enabled parental controls and the program on the current channel is blocked, you won't see a picture or hear sound while editing the channel lineup.

**Note:** Repeating the live TV channel scan unhides all hidden channels.

## Connecting your TV

If you went through Guided Setup and chose **Connect to the Internet later**—no worries. Your Roku TV makes it easy to connect whenever you're ready. As you move around the Home screen, you'll see several places where you can start the connection process. For example:

- Now and then you'll see a message appear on the panel to the right of the Home screen offering a **Connect Now** option. You can highlight and select the **Connect Now** option to get started.
- Use the **Connect and activate now** option. From the Home Screen Menu, select **Settings**, then **Network**, and then **Connect and activate now**.
- If you want to start over from the beginning, do a **Factory reset**, and then go through Guided Setup again. This time, select your home network when prompted.

## Updating a TV that is not connected

If your TV is not connected to the Internet, you can still get software updates by using a USB flash drive and a computer with an Internet connection.

To get a software update, navigate to **Settings > System > Software update**:

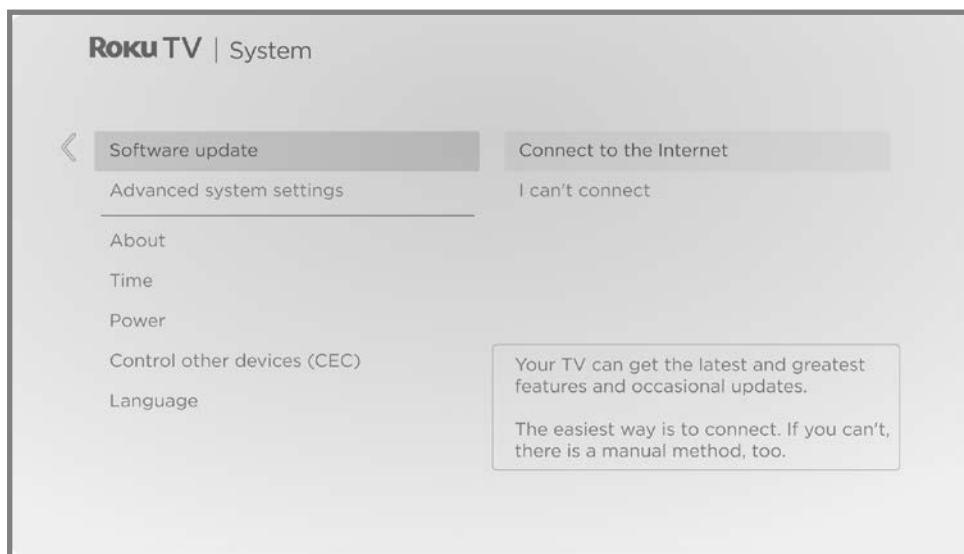

The **Software update** screen on a non-connected TV gives you the opportunity to connect your TV to the Internet to automatically receive updates. We recommend this option if it is possible in your situation. To proceed, select **Connect to the Internet** and follow the instructions in [Connecting your TV](#).

Otherwise, if you can't connect to the Internet, select **I can't connect**, and then follow the instructions on the screen. Here's a summary:

1. On an Internet-connected computer, go to the web site displayed on the **Software update** screen.
2. On the **USB Update** web page, select the correct brand and model, and then click **Next**.
3. Click **Download Software**, and then save the file to the root folder of a standard USB flash drive.

---

### USB flash drive

Any normal USB flash drive will work, provided it has a FAT-16 or FAT-32 file system format. (This is the default for most flash drives.)

The size of the download is small—usually less than 100 MB—and so will fit on most any size flash drive you might have.

- 
4. When the download finishes, take the USB flash drive to the TV and plug it into the USB port. When you do, the TV validates the files on the flash drive and displays a 12-digit code.
  5. Write down the code and the web address, and take this information back to your Internet-connected computer.
  6. On the **12-digit code** page, enter the code your TV displayed, and then click **Next**.
  7. On the **6-digit code** page, write down the 6-digit code that appears, and then take it back to your TV.

---

## 12- and 6-digit codes

The USB update process uses a pair of codes to validate that you are authorized to install an update, and to ensure you are not attempting to install an old, unsupported version of the system software.

---

8. Using the TV remote, select **Next** to move to the next screen, and then use the on-screen keyboard to enter the 6-digit code. When finished, select **OK**. The software update begins. Do not remove the USB flash drive until the TV restarts.

When the update finishes, the TV restarts. You can check the new version number by navigating to **Settings > System > About**.

# FAQ

For the latest answers to Frequently Asked Questions, visit the Roku support website:

[go.roku.com/support](https://go.roku.com/support)



# Other information

## FCC Information

This equipment has been tested and found to comply with the limits for a Class B digital device, pursuant to Part 15 of the FCC Rules. These limits are designed to provide reasonable protection against harmful interference in a residential installation. This equipment generates, uses, and can radiate radio frequency energy and, if not installed and used in accordance with the instructions, may cause harmful interference to radio communications. However, there is no guarantee that interference will not occur in a particular installation. If this equipment does cause harmful interference to radio or television reception, which can be determined by turning the equipment off and on, the user is encouraged to try to correct the interference by one or more of the following measures:

- Reorient or relocate the receiving antenna.
- Increase the separation between the equipment and receiver.
- Connect the equipment into an outlet on a circuit different from that to which the receiver is connected.
- Consult the dealer or an experienced radio/TV technician for help.

This Class B digital apparatus complies with Canadian ICES-003.

This series include models (S350R/S310R)

This device complies with part 15 of the FCC Rules. Operation is subject to the following two conditions:

- (1) This device may not cause harmful interference, and
- (2) this device must accept any interference received, including interference that may cause undesired operation.

Supplier Name: TTE Technology, Inc. (dba TCL North America)

Supplier Address: 189 Technology Drive Irvine, CA 92618, USA

Supplier phone number and internet contact information: 1-877-300-8837  
support.tcl.com/us.

## Battery CAUTION & Disposal Information

1. For best results, use alkaline-type batteries.
2. Do not mix Alkaline, Standard (Carbon-Zinc), or Rechargeable (Nickel Cadmium or Nickel Metal Hydride) batteries.
3. Always replace depleted batteries with two same brand-new batteries from the same manufacturer. Never use damaged batteries.
4. Do not use Rechargeable (Nickel Cadmium or Nickel Metal Hydride) batteries.
5. Install only new batteries of the same type in your product. There is a risk of fire or explosion if the battery is replaced by an incorrect type.
6. Do not mix old and new batteries.
7. Batteries should not be exposed to excessive heat, such as prolonged direct sunlight, open flame, or fire of any kind as it may result in an explosion, or leakage of flammable liquid, or gas.

8. Batteries should not be exposed to extremely low air pressure as it may result in an explosion or the leakage of flammable liquid or gas.
9. Failure to insert batteries in the correct polarity, as indicated in the battery compartment, may shorten the life of the batteries or cause batteries to leak.
10. Batteries should be recycled or disposed of as per state and local guidelines. Do not dispose of batteries in a fire, hot oven, or mechanically crushing or cutting a battery, which may result in an explosion.

## Electronics & Packaging Recycling Information

For information on recycling your old TVs, sound bars, and home comfort products, and to find drop-off locations in your area, please visit the “Electronics Recycling” area of the TCL website at [www.tcl.com](http://www.tcl.com). Click on our convenient interactive map to quickly locate a solution in your community. TCL encourages consumers to always look for a recycling or reuse alternative to discarding televisions and other electronics, and in many areas, TCL has programs for consumers to drop-off and recycle televisions free of charge.

Look for convenient How2Recycle® labels on the product box for help preparing your new TV packaging for recycling. These labels show important information identifying the various types of packaging material included with your new TV along with easy-to-understand recycling instructions.

**Warning:** *To avoid the danger of suffocation, keep plastic packaging away from pets, babies, and children. Do not use packaging bags in cribs, beds, carriages, or playpens.*

## Care and Cleaning

- **Caution:** Turn off your TV before cleaning.
- Clean the TV as needed using a soft lint-free cloth. Be sure to occasionally dust the ventilation slots in the cabinet to help assure adequate ventilation.
- **IMPORTANT:** Never use strong cleaning agents, such as ammonia-based cleaners, or abrasive powder. These types of cleaners will damage the TV. The TV’s screen may be cleaned with a soft, lint-free cloth as well. Take care not to scratch or mar the screen. If necessary, you may use a cloth dampened with warm water. While cleaning, do not spray liquid directly on the screen, or allow liquid to run down the screen and inside the TV. Also, never place drinks or vases with water on top of the TV. This could increase the risk of fire, shock hazard or damage to the TV.

## Television Specifications

- Broadcasting system US System NTSC-M, ATSC standard (8VSB), QAM
- Receiving Channels VHF2-13, UHF14-69, CATV 14-36 (A)-(W), 37-59 (AA)-(WW), 60-85 (AAA)-(ZZZ), 86-94 (86)-(94), 95-99 (A-5)-(A-1), 100-135(100)-(135), 01 (4A)
- Tuner type Frequency synthesized
- Operating Temperature 5°C to 35°C (41°F to 95°F)
- Operating Humidity 20% to 80%, non-condensing
- Storage Temperature -15°C to 45°C (5°F to 113°F)
- Storage Humidity 10% to 90%, non-condensing

# Notices

## TCL NORTH AMERICA LIMITED PRODUCT WARRANTY

All New TCL Product Models including LCD/LED Televisions, Sound Bars, and Appliances including Window Air Conditioners, Portable and Through-The-Wall Air Conditioners, Dehumidifiers, Air Purifiers, and Robot Vacuums (each individually referred to as a “Product” or “Unit”, and together referred to as the “Products”).

**What your warranty covers:** Defects in materials or workmanship to the original owner of this TCL Product when purchased as new from an Authorized Dealer of TCL brand Products in the United States and packaged with this warranty statement.

### New Products (Non-Commercial Use)

For how long after your purchase:

- **One (1) year from date of purchase** for parts and labor for **non-commercial use**.

### New Products (Commercial Use)

For how long after your purchase:

- **Six (6) months from date of purchase** for parts and labor for **commercial use**.

Commercial use includes, but is not limited to, the use of this Product in a commercial or business environment, the use of this Product in an institution or for institutional purposes, or other commercial purposes including rental purposes.

### What we will do

- At TCL’s discretion, (1) pay an Authorized TCL Service Center for both labor charges and parts to repair your Product, or (2) replace your Product with a new or refurbished/remanufactured equivalent value Product. The decision to repair or replace will be made solely by TCL. See section entitled “How to get service.”

### How to get service

- Before submitting a request for warranty service, please visit [support.tcl.com](http://support.tcl.com) for helpful FAQs and additional troubleshooting suggestions.
- To get warranty service, contact TCL Customer Support by visiting [support.tcl.com/contact-us](http://support.tcl.com/contact-us). Please have your Product type, model number, serial number, and ZIP code ready. Troubleshooting and prior approval from a TCL representative **MUST** occur before sending in your Product to a TCL Service Center.
- A representative must troubleshoot your problem over the telephone, via chat, or through e-mail before receiving service. If it is determined that your Unit requires service, the service location will be at the sole discretion of TCL based upon the Limited Warranty Statement.
- At the sole discretion of TCL, television screen sizes 43-inches and smaller will either be repaired at an Authorized TCL Service Center or directly exchanged for a new or refurbished/re-certified Unit. At the sole discretion of TCL, television screen sizes 44-inches or larger will either be repaired or directly exchanged for a new or refurbished/re-certified Unit at an Authorized TCL Service Center or in-home. At the sole discretion of TCL, Sound Bars, and Appliances including Window Air Conditioners, Portable and Through-The-Wall Air Conditioners, Dehumidifiers, Air Purifiers, and Robot Vacuums will either be repaired or directly exchanged for a new or refurbished/re-certified Unit at an Authorized TCL Service Center or in-home. In the event of a service visit where the on-site technician, in his-her sole discretion, deems the home or property conditions to be hazardous and/or unsafe, TCL reserves the right to cancel or re-schedule the service visit, or opt for an

exchange of the in-warranty Unit for a refurbished/re-certified Unit in lieu of the in-home service visit.

- TCL is not responsible for transportation costs for warranty coverage, including but not limited to Unit repair or replacement, to the Authorized TCL Service Center or TCL-designated address. However, TCL will pay for return shipping to a United States address only. TCL will provide instructions for packaging and shipping the Unit to the Authorized TCL Service Center or TCL-designated address. **Units that are improperly packed and damaged during shipping are not covered under your limited Product warranty.**
- Proof of purchase in the form of a bill of sale or receipted invoice from an Authorized Dealer which is evidence that the Product is within the warranty period must be presented to obtain warranty service.
- In the event that a Unit is to be replaced, a picture of the back of the Unit showing the model and serial number and picture of the Product issue itself may be required.
- PRE-AUTHORIZATION MUST BE OBTAINED BEFORE (1) SENDING ANY PRODUCT TO AN AUTHORIZED TCL SERVICE CENTER, OR (2) OBTAINING ANY IN-HOME REPAIR/REPLACEMENT/RENTAL SERVICES.

#### What your warranty does not cover

- A Unit sold in “As-Is”, “Used”, “Factory Reconditioned”, “Factory Re-Certified”, or “Refurbished”, condition or with faults.
- Damage caused by transportation or handling, including damage during shipment from a Retailer (please contact your Retailer for assistance).
- Extended Service Plans purchased from Retailers. Please contact your Retailer for assistance.
- Customer instruction. (Your Owner’s Manual describes how to install, adjust, and operate your Unit. Any additional information should be obtained from your Authorized Dealer).
- Service calls to your home for delivery or pick-up, installation, instruction, replacement of house fuses, connection of house wiring or plumbing, or to correct unauthorized repairs.
- Installation and related adjustments, or damage resulting from installation.
- Damage resulting from non-approved installation or repair methods.
- Failure of the Product to perform due to signal reception problems not caused by your Unit, or due to power failures or interruptions, or inadequate electrical service.
- Damage from misuse, abuse, neglect, insects, normal wear and tear, cosmetic damage, mishandling, faulty installation, inadequate electrical wiring, or power line surges.
- Damage caused by operating the Product in a corrosive or wet atmosphere.
- Markings or images on the television’s panel resulting from viewing fixed images (including but not limited to certain 4:3 images on wide screen televisions, or data or images in fixed screen locations from banners, video games, or certain broadcast networks).
- Units that have original factory serial numbers that are unreadable or missing, or that have been changed, defaced, or altered in any manner.
- Batteries.
- A television that has been modified or incorporated into other Products, or that has had the serial number removed or altered.
- Use of accessories or components that are not compatible with this Product.
- A Unit purchased or serviced outside of the United States.
- Costs of shipping the Unit to the Authorized TCL Service Center or TCL-designated address. TCL will pay for return shipping to the customer to a United States address only.
- Acts of nature or God (as illustrative examples and for the avoidance of doubt, such acts of nature or God include but are not limited to damage caused by earthquakes, fires, lightning, or flood whether caused by nature or humans).
- Special, incidental, or consequential damages.

## LIMITATION OF WARRANTY

- THE WARRANTY STATED ABOVE IS THE ONLY WARRANTY APPLICABLE TO THIS PRODUCT. NO VERBAL OR
- WRITTEN INFORMATION GIVEN BY TTE TECHNOLOGY, INC. DBA TCL NORTH AMERICA, ITS AGENTS OR EMPLOYEES SHALL CREATE A GUARANTY OR IN ANY WAY INCREASE OR MODIFY THE SCOPE OF THIS WARRANTY.
- REPAIR OR REPLACEMENT AS PROVIDED UNDER THIS WARRANTY IS THE EXCLUSIVE REMEDY OF THE CONSUMER. TTE TECHNOLOGY, INC. DBA TCL NORTH AMERICA SHALL NOT BE LIABLE FOR SPECIAL, INCIDENTAL, OR CONSEQUENTIAL DAMAGES RESULTING FROM THE USE OF THIS PRODUCT OR ARISING OUT OF ANY BREACH OF ANY EXPRESS OR IMPLIED WARRANTY ON THIS PRODUCT. THIS DISCLAIMER OF WARRANTIES AND LIMITED WARRANTY ARE GOVERNED BY THE LAWS OF THE STATE OF CALIFORNIA. EXCEPT TO THE EXTENT PROHIBITED BY APPLICABLE LAW, ANY IMPLIED WARRANTY OF MERCHANTABILITY OR FITNESS FOR A PARTICULAR PURPOSE ON THIS PRODUCT IS LIMITED TO THE APPLICABLE WARRANTY AND WARRANTY PERIOD SET FORTH ABOVE. THIS WARRANTY IS SUBJECT TO CHANGE WITHOUT NOTICE. PLEASE VISIT [WWW.TCL.COM](http://WWW.TCL.COM) TO VIEW THE MOST CURRENT VERSION.

### How State Law relates to this warranty

- Some states may not allow the exclusion or limitation of incidental or consequential damages, or limitations on how long an implied warranty lasts, so the above limitations or exclusions may not apply to you.
- This warranty gives you specific legal rights, and you also may have other rights that vary from state to state.

**If you purchased your Unit outside of the United States or seek warranty service coverage outside of the United States**, this warranty does not apply. Contact your dealer for warranty information.

**Service calls which do not involve defective materials or workmanship are not covered by this limited warranty. Costs of such service calls are the sole responsibility of the purchaser.**

### CONTACT INFORMATION:

TCL North America  
189 Technology Drive  
Irvine, CA 92618, USA  
1- 877-300-8837  
[www.tcl.com/us](http://www.tcl.com/us)

## Legal statement

In Your use of the TCL • Roku TV is subject to the [Roku TV Terms of Use](#). Your Roku account and other features and functionality offered by Roku may be subject to additional terms. To learn more visit [roku.com/legal/docs](http://roku.com/legal/docs)

## Dolby Audio™

Manufactured under license from Dolby Laboratories. Dolby, Dolby Audio, and the double-D symbol are registered trademarks of Dolby Laboratories Licensing Corporation. Copyright 1992-2023 Dolby Laboratories. All rights reserved.



## HDMI®

The terms HDMI® and HDMI™ High-Definition Multimedia Interface, and the HDMI® Logo are trademarks or registered trademarks of HDMI® Licensing LLC in the United States and other countries.



## Roku

ROKU, ROKU TV and the ROKU logo are the trademarks or registered trademarks of Roku, Inc. All other trademarks and logos herein are the property of their respective owners.





